

2300 COMBINED SONAR SYSTEM

USER HARDWARE MANUAL

019849_REV_D

8/18/2020



EdgeTech

4 Little Brook Road
West Wareham, MA 02576

Tel: (508) 291-0057

Fax: (508) 291-2491

www.EdgeTech.com

The information, figures, and specifications in this manual are proprietary. They are issued in strict confidence on condition that they not be copied, reprinted, or disclosed to a third party, either wholly or in part, without the prior written consent of EdgeTech. Any reproduction of EdgeTech supplied software or file sharing is strictly prohibited.

EdgeTech© 2019-2020. All rights reserved.

Microsoft Windows© is a registered trademark of Microsoft Corporation

SBG© is a registered trademark of SBG Systems

ATTENTION – READ THIS FIRST!

Warnings, Cautions, and Notes

Where applicable, warnings, cautions, and notes are provided in this manual as follows:

WARNING!

Identifies a potential hazard that could cause injury or death.

CAUTION!

Identifies a potential hazard that could damage equipment or data.

NOTE: Recommendations or general information that is particular to the material being presented.

All personnel involved with the installation, operation, or maintenance of the equipment described in this manual should read and understand the warnings and cautions provided below.

CAUTION!

This equipment contains devices that are extremely sensitive to static electricity. Therefore, extreme care should be taken when handling them. Normal handling precautions involve the use of anti-static protection materials and grounding straps for personnel.

WARNING!

High Voltage may be present in all parts of the system. Therefore, use caution when the electronics are removed from their containers for servicing.

CAUTION!

Operation with improper line voltage may cause serious damage to the equipment. Always ensure that the proper line voltage is used.

HARDWARE VARIATIONS AND COMPATIBILITY

The 2300 Combined Sonar System contains both standard and proprietary hardware. At times, EdgeTech may change the standard components due to their availability or performance improvements. Although the component manufacturers—along with their models and styles—may change from unit to unit, replacement parts will generally be interchangeable.

EdgeTech will make every effort to see that replacement components are interchangeable and use the same software drivers (if applicable). At times, however, direct replacements may not exist. When this happens, EdgeTech will provide the necessary drivers with the replacement part, if applicable.

EdgeTech may also change certain hardware per customer requirements. Therefore, portions of this manual, such as parts lists and test features, are subject to change. These sections should be used for reference only. When changes are made that affect system operation, they will be explicitly noted. Also, some options and features may not be active in the customer's unit at the time of delivery. Upgrades will be made available when these features are implemented.

Contact [EDGETECH CUSTOMER SERVICE](#) with any questions relating to compatibility.

ABOUT THIS DOCUMENT

We, the employees at EdgeTech, would like to thank you for purchasing a 2300 Combined Sonar System. At EdgeTech, it is our policy to provide high-quality, cost-effective products and support services that meet or exceed your requirements. We also strive to deliver them on-time and to continuously look for ways to improve them. We take pride in the products we manufacture and want you to be entirely satisfied with your equipment.

Purpose of this Manual

The purpose of this manual is to provide the user with information on the setup and use of EdgeTech's 2300 Combined Sonar System. Although this manual encompasses the latest operational features of the 2300 Combined Sonar System, some features may be periodically upgraded. Therefore, the information in this manual is subject to change and should be used for reference only.

Liability

EdgeTech has made every effort to document the 2300 Combined Sonar System in this manual accurately and completely. However, EdgeTech assumes no liability for errors or for any damages that result from the use of this manual or the equipment it documents. EdgeTech reserves the right to upgrade features of this equipment and to make changes to this manual, without notice at any time.

Revision History

REV	DESCRIPTION	DATE	APPROVAL
A	Release to Customer	11/6/2019	DMD
B	Updated Images, Bridle and Shipping Instructions	12/16/2019	DMD
C	AUV/ROV Update	6/23/2020	DMD
D	Cable Notes Added	8/18/2020	DMD

WARRANTY STATEMENT

All equipment manufactured by EdgeTech is warrantied against defective components and workmanship for a period of one year after shipment. Warranty repair will be done by EdgeTech free of charge.

Shipping costs are to be borne by the customer. Malfunction due to improper use is not covered in the warranty, and EdgeTech disclaims any liability for consequential damage resulting from defects in the performance of the equipment. No product is warranted as being fit for a particular purpose, and there is no warranty of merchantability. This warranty applies only if:

- i. The items are used solely under the operating conditions and in the manner recommended in Seller's instruction manual, specifications, or other literature.
- ii. The items have not been misused or abused in any manner, nor have repairs been attempted thereon without the approval of EdgeTech Customer Service.
- iii. Written notice of the failure within the warranty period is forwarded to Seller, and the directions received for properly identifying items returned under warranty are followed.
- iv. The return notice authorizes Seller to examine and disassemble returned products to the extent Seller deems necessary to ascertain the cause for failure.

The warranties expressed herein are exclusive. There are no other warranties, either expressed or implied, beyond those set forth herein, and Seller does not assume any other obligation or liability in connection with the sale or use of said products. Any product or service repaired under this warranty shall be warranted for the remaining portion of the original warranty period only.

Equipment not manufactured by EdgeTech is supported only to the extent of the original manufacturer's warranties.

CAUTION! If your product is a portable topside, never attempt to ship it in its Storm Case™ alone. Shipping portable topsides without an exterior shipping crate will void the warranty.

SOFTWARE SERVICE OVERVIEW

EdgeTech provides software services free of charge. This software agreement does not address customer-specified modifications or enhancements. These services may be ordered separately. Furthermore, EdgeTech software upgrades are meant for the sole use of EdgeTech customers. Any reproduction of EdgeTech-supplied software or file sharing is strictly prohibited.

Software Updates and Enhancements

EdgeTech customers can download new software releases with all modifications and enhancements from the EdgeTech FTP site. Major software issues, should they occur, will be reported directly to the customer. New software releases consist of the following:

- Software enhancements that are not on the price list
- Software fixes and changes
- Product integration
- Documentation updates to on-line help
- Tests for compatibility with other modules

Software patches consist of software that has undergone the following:

- Minor software enhancements
- Software fixes and changes

EdgeTech customers are entitled to contact **EDGE TECH CUSTOMER SERVICE** by telephone, facsimile, or e-mail to report a difficulty, to discuss a problem, or to receive advice on the best way to perform a task. When contacted, EdgeTech Customer Service will do the following:

- Respond within 24 hours via Software Telephone, Facsimile, and E-mail Support
- Immediately attend to serious problems affecting operations
- Attempt to find an immediate workaround

RETURNED MATERIAL AUTHORIZATION

Prior to returning any equipment to EdgeTech, a Returned Material Authorization (RMA) Number must be obtained from **CUSTOMER SERVICE**.

RMA Purpose

The RMA Number identifies returned equipment when it arrives at our receiving dock and enables tracking while at our facility. Refer to the RMA number on all documentation and correspondences.

All returned materials must be shipped prepaid. Freight collect shipments will not be accepted. All equipment should be adequately insured for shipping, but equipment belonging to EdgeTech must be insured for full value.

If there is more than one item per consignment, include a packing with the shipment. An invoice can double as a packing slip only when the contents are clearly numbered and identified on the invoice.

CAUTION! Never attempt to ship a Portable Topside in its Storm Case™ alone. Although rugged, these cases are not intended to be used as shipping containers, and the delicate internal components could be damaged. Shipping in this manner will void any warranties.

NOTE: All shipping charges shall be the responsibility of the customer, unless under warranty, as EdgeTech will pay for return shipping.

NOTE: For International Shipments valued over \$1000, the following Shipper's oath must be sent with the invoice.

Shipper's Oath:

"I, _____, declare that the articles herein specified are the growth, produce, or manufacture of the United States; that they were exported from the United States from the port of _____, on or about _____; that they are returned without having been advanced in value or improved in condition by any process of manufacture or any other means; and that no drawback, or allowance has been paid or admitted hereof."

Signed _____

CUSTOMER SERVICE

Customer service personnel at EdgeTech are always eager to hear from users of our products. Your feedback is welcome and is a valuable source of information that we use to improve these products. Therefore, we encourage you to contact EdgeTech Customer Service to offer any suggestions or to request technical support:

NOTE: Please have your system Model and Serial Number available when contacting Customer Service.

E-mail: service@edgetech.com

Mail: 4 Little Brook Road
West Wareham, MA 02576

Telephone: (508) 291-0057

Facsimile: (508) 291-2491

**24-Hour Emergency
Technical Support Line:** (508) 942-8043

For more information, please go to WWW.EDGE TECH.COM.

COMPANY BACKGROUND

EdgeTech (formerly EG&G Marine Instruments) traces its history in Underwater Data Acquisition and Processing back to 1966. EdgeTech has designed, developed, and manufactured products, instruments, and systems — for the acquisition of underwater data, including marine, estuarine, and coastal applications — for over 50 years.

EdgeTech responds to the needs of the Scientific, Naval, and Offshore communities by providing industry-leading equipment — such as Sub-Bottom Profilers, Side Scan Sonar, Acoustic Releases, USBL Positioning Systems, and Bathymetric Systems — that have become standards in the industry.

EdgeTech consistently anticipates and responds to future needs with an active Research and Development Program. Current efforts are focused on adapting new cutting-edge acoustic technology.

TABLE OF CONTENTS

ATTENTION – READ THIS FIRST!	iii
HARDWARE VARIATIONS AND COMPATIBILITY	iv
ABOUT THIS DOCUMENT	v
Liability.....	v
Revision History.....	v
WARRANTY STATEMENT	vi
SOFTWARE SERVICE OVERVIEW	vii
RETURNED MATERIAL AUTHORIZATION	viii
CUSTOMER SERVICE	ix
COMPANY BACKGROUND	x
TABLE OF CONTENTS	xi
LIST OF FIGURES	xiv
LIST OF TABLES	xvii
1.0 OVERVIEW	1-1
1.1 Key Features.....	1-1
1.2 2300 Combined Sonar System Applications.....	1-3
1.3 Main System Components.....	1-4
1.3.1 Rack-Mounted Topside.....	1-4
1.3.2 Tow and Test Cables.....	1-4
1.3.3 2300 Towfish.....	1-4
1.4 Optional Equipment.....	1-6
1.4.1 MPES Bathymetry Sonar.....	1-6
1.4.2 USBL Beacon.....	1-6
1.4.3 Magnetometer Interface.....	1-7
2.0 SPECIFICATIONS	2-8
2.1 Towfish Specifications.....	2-8
2.2 Rack Mount Topside Specifications.....	2-10
2.2.1 Rackmount General Specifications.....	2-10
2.2.2 Rack Mount Topside Computer Specifications.....	2-10
2.2.3 Rack Mount Topside Starmux IV Specifications.....	2-11

2.3	Optional Cable Specifications.....	2-11
2.3.1	Tyco Dataline A302799 Double-Armored Coaxial Tow Cable.....	2-11
2.4	2300 Mechanical Drawings	2-12
2.4.1	Towfish Mechanical Drawings	2-12
2.4.2	Sonar Processor Electronics Bottle	2-13
2.4.3	Multiplexer Electronics Bottle	2-14
2.4.4	2300 Rackmount Drawing	2-15
3.0	TECHNICAL DESCRIPTION	3-16
3.1	Towfish Technical Description.....	3-16
3.1.1	System Connection Diagram	3-17
3.1.2	Multiplexer and Sonar Processor Endcap Diagrams	3-18
3.1.3	Cables	3-22
3.2	Rack Mount Topside Technical Description	3-24
3.2.1	Starmux IV Controls, Indicators, and Connections	3-24
3.2.2	Computer Controls and Connections	3-25
4.0	SYSTEM SETUP	4-28
4.1	Unpacking and Inspecting	4-28
4.2	Towfish Bridle Adjustments for Towing, Movement, and Transport	4-29
4.2.1	Adjusting Bridle Strut Position for Towing Movement and Transport.....	4-29
4.2.2	Configuring the 2300 for Shipping and Transport	4-31
4.3	Power Requirements	4-33
4.3.1	Use of an Uninterrupted Power Supply	4-33
4.3.2	Changing to a Non-US Power Plug	4-34
4.4	Navigation Interface	4-34
4.5	Topside Processor Placement	4-34
4.6	IP Address Settings	4-35
4.7	Connecting the System Components.....	4-35
4.7.1	Connecting the Starmux IV to a Computer.....	4-35
4.7.2	Connecting and Attaching the Tow Cable to the Towfish	4-36
4.7.3	Connecting the Tow Cable to the Starmux IV.....	4-37
4.7.4	Connecting An Optional Magnetometer	4-37
5.0	ACTIVATION, TEST, AND DEPLOYMENT	5-38

5.1	Activating a 2300-Rack Mount System	5-38
5.2	Performing System Pre-Deployment Testing	5-40
5.2.1	Testing the Sonar Processor	5-40
5.2.2	Performing Side-Scan Pre-Deployment Checks	5-41
5.2.3	Performing Sub Bottom Pre-Deployment Checks.....	5-44
5.3	Towfish Deployment.....	5-46
5.4	Towfish Layback Charts.....	5-48
5.4.1	Cable A302799 Layback Charts:	5-49
5.5	Towfish Recovery.....	5-52
6.0	MAINTENANCE	6-54
6.1	Cleaning and Inspecting the Towfish After Use.....	6-54
6.2	Tail Fin Removal and Installation.....	6-54
6.2.1	Tail fin Removal.....	6-54
6.2.2	Tail Fin Installation	6-57
6.3	Opening the Towfish.....	6-58
6.4	Electronics Bottle Installation and Removal	6-59
6.4.1	Removing Vertically Mounted Sub-Bottom Transducer	6-60
6.4.2	Installing Sub-Bottom Transducers	6-61
6.4.3	Removing Horizontally Mounted Electronic Bottles	6-64
6.4.4	Installing Horizontally Mounted Electronic Bottles	6-66
6.5	Towfish Weight Adjustment.....	6-68
7.0	TROUBLESHOOTING	7-70
7.1	Towfish Troubleshooting Guide	7-70
7.1.1	Towfish	7-71
7.1.1.1	No Sonar Data	7-71
7.1.1.2	Reported Errors.....	7-71
7.2	Starmux IV Troubleshooting.....	7-72
7.3	Computer System Restoration	7-73
8.0	Kits:	8-75
8.1	AUV/ROV Mounting Kit.....	8-75

LIST OF FIGURES

Figure 1-1: 2300 Towfish- Top-down internal view	1-1
Figure 1-2: 850 kHz Side Scan Imagery of Machen Shipwreck	1-2
Figure 1-3: 4 x 1-10 kHz Sub-Bottom Imagery	1-2
Figure 1-4: EdgeTech Discover Bathymetry	1-3
Figure 1-5: 2300 Rackmount	1-4
Figure 1-6: Test Cable	1-4
Figure 1-7: 2300 Towfish Sideview	1-5
Figure 1-8: 2300 Top-Forward View	1-6
Figure 1-9: 2300 Top-Aft View	1-6
Figure 1-10: 2300 Towfish Magnetometer Shackle	1-7
Figure 2-1: 2300 Towfish ICD	2-12
Figure 2-2: Sonar Processor Bottle ICD	2-13
Figure 2-3: 2300 Multiplexer ICD	2-14
Figure 2-4: 2300 Rack Mount Drawing	2-15
Figure 3-1: 2300 Towfish Top-Down Internal View with Component Callouts	3-16
Figure 3-2: 2300 Topside System Connection Diagram	3-17
Figure 3-3: 2300 Subsea Hardware Configuration	3-18
Figure 3-4: Non-Bathymetric Sonar Processing Endcap Drawing	3-19
Figure 3-5: Bathymetric Sonar Processor Endcap Drawing	3-20
Figure 3-6: 2300 Subsea Multiplexer Endcap Drawing	3-21
Figure 3-7: MCIL6F to MCIL6M Extension Cable	3-22
Figure 3-8: Test Cable	3-23
Figure 3-9: Labeled Front Panels of 2300 Rackmount	3-26
Figure 3-10: Labeled Rear Picture of 2300 Rackmount	3-27
Figure 4-1: Towfish Bridle	4-29
Figure 4-2: Support Strut	4-29
Figure 4-3: Bridle Support Strut Adjustment	4-30
Figure 4-4: 90° Bridle Position	4-30
Figure 4-5: Bridle Winch or Crane Movement ~ 80° Position	4-31

Figure 4-6: Bridle at ~ 80° Position For Crating and Transport.....	4-32
Figure 4-7: 2x4 Installation in Crating to Restrict Verticle and Lateral Movement.....	4-33
Figure 4-8: Starmux IV and Computer Connected By Ethernet Cable.....	4-36
Figure 4-9: Starmux IV Sea Cable Connector	4-37
Figure 5-1: WebRelay Control Interface	5-39
Figure 5-2: Command Prompt Ping Test.....	5-40
Figure 5-3: Sonar.exe Successful Self-Test.....	5-41
Figure 5-4: Status Indicator Bar- NET:ON	5-41
Figure 5-5: Sidescan Control Tab in Discover.....	5-42
Figure 5-6: Side Scan Control Tab Frequency, Duration, and Signal Meter Datablocks.....	5-42
Figure 5-7: Disk Control Tab, Record File Text Box, Browse File Button, and Start Recording Button Locations.....	5-43
Figure 5-8: External Device Controls- Zero Pressor Sensor Button.....	5-43
Figure 5-9: Disk Control Tab: Stop Recording Button, Browse for Recording and Play Button	5-43
Figure 5-10: Discover 2300 Sub-Bottom Display Window.....	5-44
Figure 5-11: The Sub-Bottom Control Tab.....	5-45
Figure 5-12: Sub-Bottom Control Tab-Pulse and Transmit Level Called Out.....	5-45
Figure 5-13: Sub-Bottom Shortcut Toolbar- Range Text Field and Normalize Gain Button Called Out ..	5-45
Figure 5-14: Tap Test	5-46
Figure 5-15: Bottom Track Tab.....	5-48
Figure 5-16: 2300 Being Recovered.....	5-52
Figure 6-1: View of Inner-Fin Bolt Mounting (Hex Nuts, Washers).....	6-55
Figure 6-2: Outer-Fin Bolt Mounting (Hex-head Bolts)	6-55
Figure 6-3: Unthreading Tail Wing Assembly with Hex Screwdriver and Wrench.....	6-56
Figure 6-4: Tail Fin Alignment (Tail Fin and Model Number out).....	6-57
Figure 6-5: Inner Tail Bolt Positions (future versions will be fixed and not adjustable).....	6-58
Figure 6-6: Top Cover Hex Screw Removal	6-59
Figure 6-7: Mounted Sub-Bottom Transducer secured by Mounting Brackets and Worm Clamp.....	6-60
Figure 6-8: Vertical Mounting Brackets Proper Alignment.....	6-62
Figure 6-9: Worm Clamp Secured Around Mounting Brackets and Transducer.....	6-63
Figure 6-10: Correctly Installed Sub-Bottom Transducer	6-63

Figure 6-11: Aft Horizontally Installed Electronics Bottle 6-65

Figure 6-12: Detached Mounting Ring..... 6-65

Figure 6-13: Aft Mounting Ring Bolt Hole Locations 6-67

Figure 6-14: Mounted Aft Mounting Ring 6-67

Figure 6-15: Forward Weight Assembly 6-68

LIST OF TABLES

Table 2-1: Towfish Specifications	2-9
Table 2-2: MPES Bathymetry Options Specifications	2-9
Table 2-3: 2300 Rackmount General Specifications	2-10
Table 2-4: Topside Computer Specifications	2-10
Table 2-5 Topside Starmux IV Specifications	2-11
Table 2-6: Optional Tyco Dataline A302799 Double-Armored Tow Cable Specifications	2-11
Table 3-1: Starmux IV, Indicators, Connections	3-24
Table 3-2: Computer Controls and Connections	3-25
Table 4-1: AC Power Cord Wiring.....	4-34
Table 5-1: 2300 with QTY 4 DW 106 Transducers and 500 Meters of Cable A302799 Paid Out	5-49
Table 5-2: 2300 with QTY 4 DW 106 Transducers and 1,000 Meters of Cable A302799 Paid Out	5-49
Table 5-3: 2300 with QTY 4 DW 106 Transducers and 2,000 Meters of Cable A302799 Paid Out	5-50
Table 5-4: 2300 with QTY 4 DW 106 Transducers and 3,000 Meters of Cable A302799 Paid Out	5-50
Table 5-5: 2300 with QTY 4 DW 106 Transducers and 4,000 Meters of Cable A302799 Paid Out	5-51
Table 5-6: 2300 with QTY 4 DW 106 Transducers and 4,500 Meters of Cable A302799 Paid Out	5-51
Table 7-1: Reported Errors.....	7-71
Table 7-2: Starmux IV Troubleshooting Table.....	7-73
Table 8-1: Main I/O (J1) Connector Configuration	8-75

1.0 OVERVIEW

The 2300 system combines EdgeTech's highly successful line of side-scan sonar, sub-bottom profiler, and MPES bathymetry technologies into one fully-integrated system. The tri-frequency side scan system provides surveyors a choice of operating any two of three frequencies simultaneously using EdgeTech's proven Full Spectrum™ CHIRP technology to provide crisp, high-resolution imagery. The 2300 sub-bottom system is designed to incorporate up to four deep-penetrating low-frequency DW-106 (1-10kHz) transducers coupled with a PVDF hydrophone receiver that provides better sub-bottom receive sensitivity and directivity. EdgeTech's MPES Bathymetry is available as an option. The Multi-Phase Echo Sounder (MPES) produces real-time, high-resolution, three-dimensional (3D) maps of the seafloor while providing co-registered simultaneous dual-frequency side-scan imagery. Additional features include a telemetry multiplexer, remote head USBL beacon, built-in heading, pitch and roll sensors, and a rear magnetometer shackle mount.

1.1 Key Features

The 2300 is a fully integrated deep-water capable side-scan and sub-bottom system that supports many options.

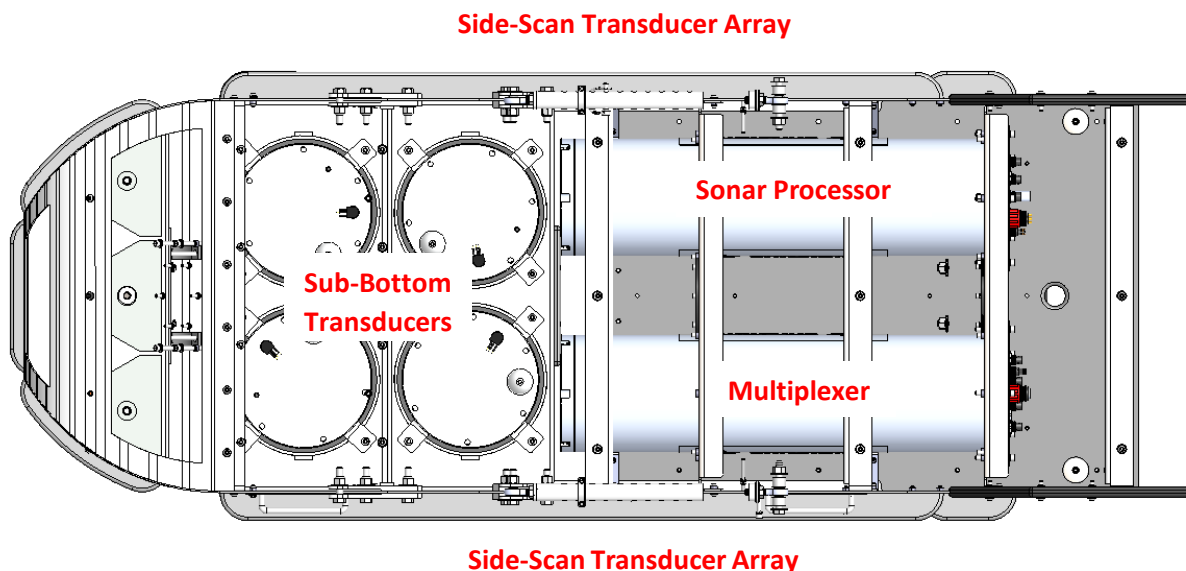

Figure 1-1: 2300 Towfish- Top-down internal view

Tri-Frequency Side Scan Sonar: A standard 2300 side-scan configuration is either a 120/410/850 kHz or 230/540/850 kHz that can operate any two frequencies simultaneously. The system frequency choice can be reconfigured instantly, allowing the operator to react and optimize range and resolutions to changing survey conditions and to use the system in multiple roles.

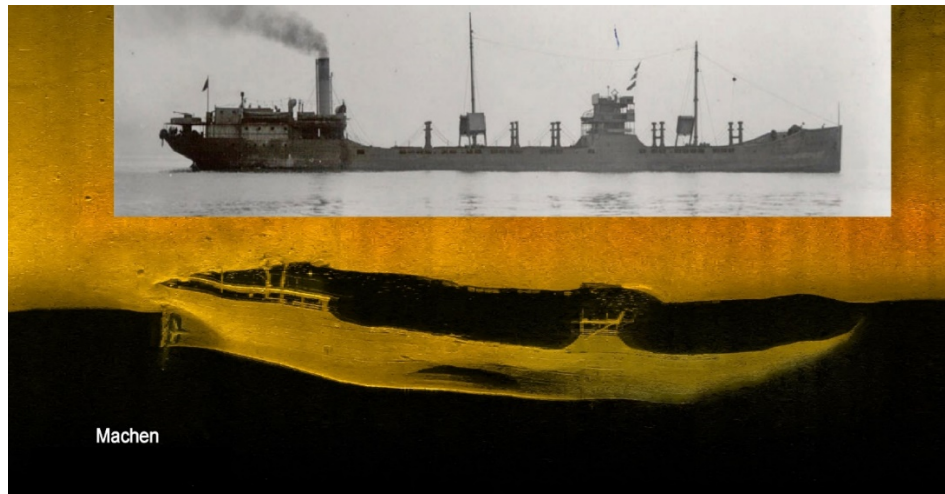

Figure 1-2: 850 kHz Side Scan Imagery of Machen Shipwreck

Sub-Bottom Sonar: The 2300 system has enhanced sub-bottom profiling capabilities with multiple low-frequency transducers and a PVDF receiver. The system mounts multiple transmit transducers in a 4 x 1-10 kHz configuration that provides improved directionality and the ability to focus power where needed. 200-Watt amplifiers drive each transducer and utilize wideband, Gaussian, and optional quadratic pulses that emphasize the lower end of the frequency spectrum over a wideband pulse. The PVDF receive panel provides 2D directionality and improved sensitivity over simple line arrays.

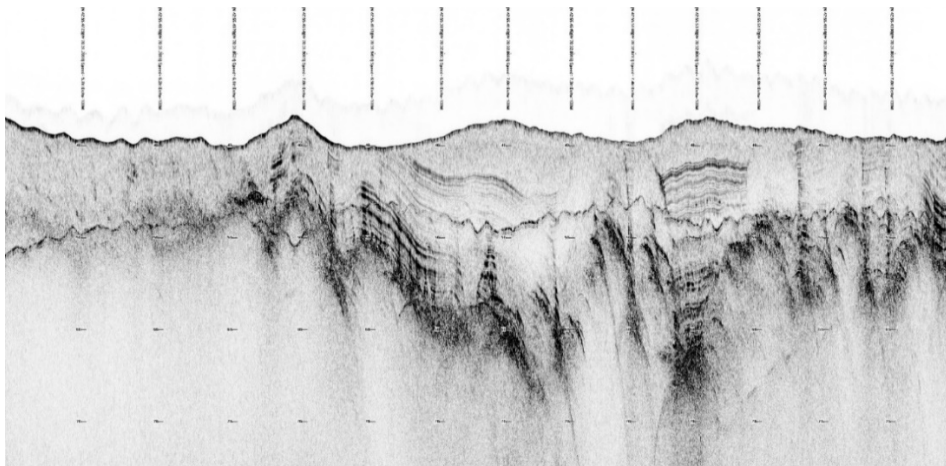

Figure 1-3: 4 x 1-10 kHz Sub-Bottom Imagery

Swath Bathymetry Option: MPES bathymetry is available on the platform. The Multi-Phase Echo Sounder (MPES) produces real-time, high-resolution, three-dimensional (3D) maps of the seafloor while providing co-registered simultaneous dual-frequency side scan imagery.

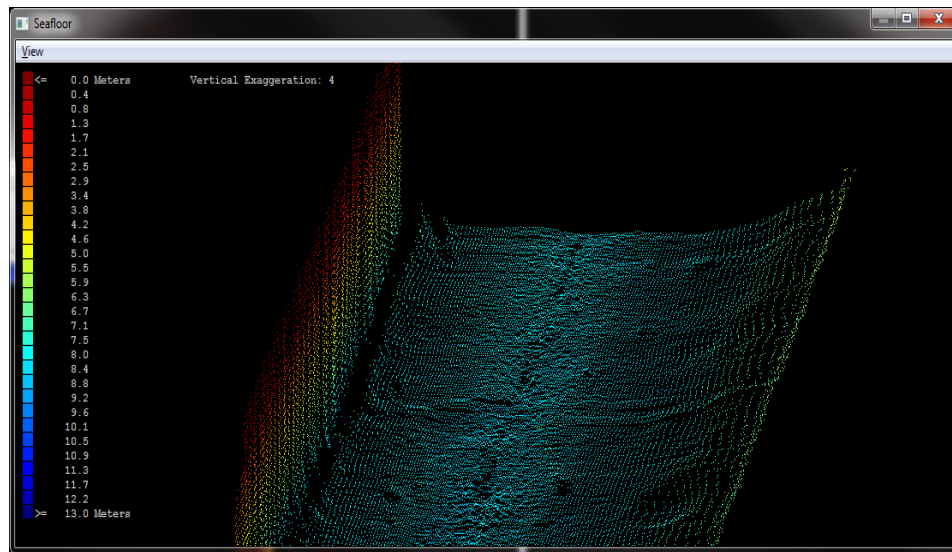

Figure 1-4: EdgeTech Discover Bathymetry

Telemetry Multiplexer: The 2300 allows the user to connect a variety of devices to an independent telemetry multiplexer that acts as a central subsea power and interface hub. All devices, including the sonar processor, connect to the multiplexer for power and data connections to the topside Starmux IV. Depending on the interface requirement, data can be broadcast on the network (Navigation) or serially provided at one of the Starmux IV rear panel RS232 connectors.

Deep Water Operations: The system is rugged and rated to a depth of 2,000 meters. An optional Edgetech armored cable provides digital Telemetry over a single coaxial type cable up to 6,000 meters in total length.

Additional Payload Options: The 2300 towfish is sized and configured to support additional payload options such as a magnetometer and USBL beacon. Contact EdgeTech Sales for options and integration details.

Built-In Heading, Pitch, and Roll Sensor: The towfish comes standard with an SBG compass that provides heading, pitch, and roll to the system. These values are displayed and updated in real-time in Discover.

1.2 2300 Combined Sonar System Applications

Applications for the 2300 Combined Sonar System are many, including:

- Archeological Surveys
- Geological/Geophysical Surveys
- Sediment Classification
- Cable and Pipeline Surveys
- Pre/Post Dredging Surveys
- Scour/Erosion Investigation

1.3 Main System Components

The 2300 system is composed of three primary components: a Rack-Mounted Topside, a 2300 towfish, and a customer supplied tow cable to connect the two.

1.3.1 Rack-Mounted Topside

The standard 2300 Rack-Mounted Topside is composed of a mounted Windows 2U Computer with EdgeTech's Discover 2300 software installed on it that interfaces with an EdgeTech Starmux IV digital telemetry link. The computer and Starmux IV provide power and communications to the towfish, support sonar and sensor display, collect data, and control the various sonars and sensors on the vehicle. This system is operated by a standard keyboard, trackball mouse, and a single widescreen video display. Additional displays are available as an option. Optionally, customers can use their PCs with Discover installed as well.



Figure 1-5: 2300 Rackmount

1.3.2 Tow and Test Cables

The 2300 towfish is connected and towed by an armored tow cable and a vessel's winch. The system comes standard with a rigid well-crafted tow bridle. Customers can purchase an EdgeTech armored tow cable and test cables or provide their own. The Towfish interfaces with the topside processor over the coaxial tow cable using asymmetric digital subscriber line (ADSL) modems in both the Towfish and the Starmux IV Telemetry System.



Figure 1-6: Test Cable

1.3.3 2300 Towfish

The 2300 is a large hydrodynamic towfish designed to accommodate multiple system payloads. The sonar electronics are contained inside a single housing where side-scan transducer arrays and sub-bottom transducers are attached. A second pressure housing contains local power distribution, telemetry, and data interfaces for optional payloads. The towfish comes standard with either a 120/410/850 kHz or

230/540/850 kHz tri-frequency side-scan sonar configuration and a quad DW 106 [1-10 kHz] sub-bottom profiler configuration.

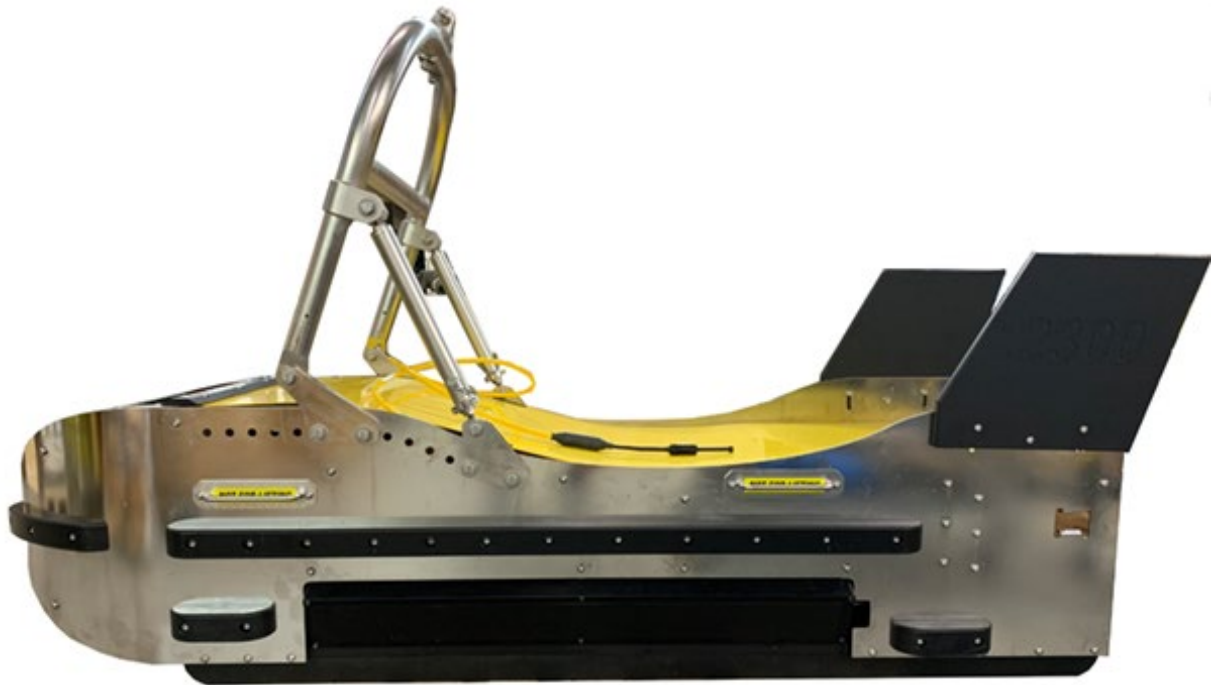

Figure 1-7: 2300 Towfish Sideview



Figure 1-8: 2300 Top-Forward View



Figure 1-9: 2300 Top-Aft View

1.4 Optional Equipment

EdgeTech offers several optional features for its 2300 system, each described in the subsections that follow.

1.4.1 MPES Bathymetry Sonar

EdgeTech's Multiphase Echo Sounder (MPES) produces real-time, high-resolution, three-dimensional (3D) maps of the seafloor while providing co-registered simultaneous dual-frequency side-scan imagery. The MPES operates at either 120 kHz or 230 kHz or 540 kHz, where the selected frequency is part of the tri-frequency side-scan triplet.

1.4.2 USBL Beacon

An ultra-short baseline (USBL) beacon provides underwater acoustic positioning of the 2300 Towfish. Consult your EdgeTech Sales Representative to discuss the best beacon option.

1.4.3 Magnetometer Interface

A magnetometer can be specified or supplied from several manufacturers with EdgeTech's optional magnetometer interface. A shackle has been added to the towfish to support towing the magnetometer.

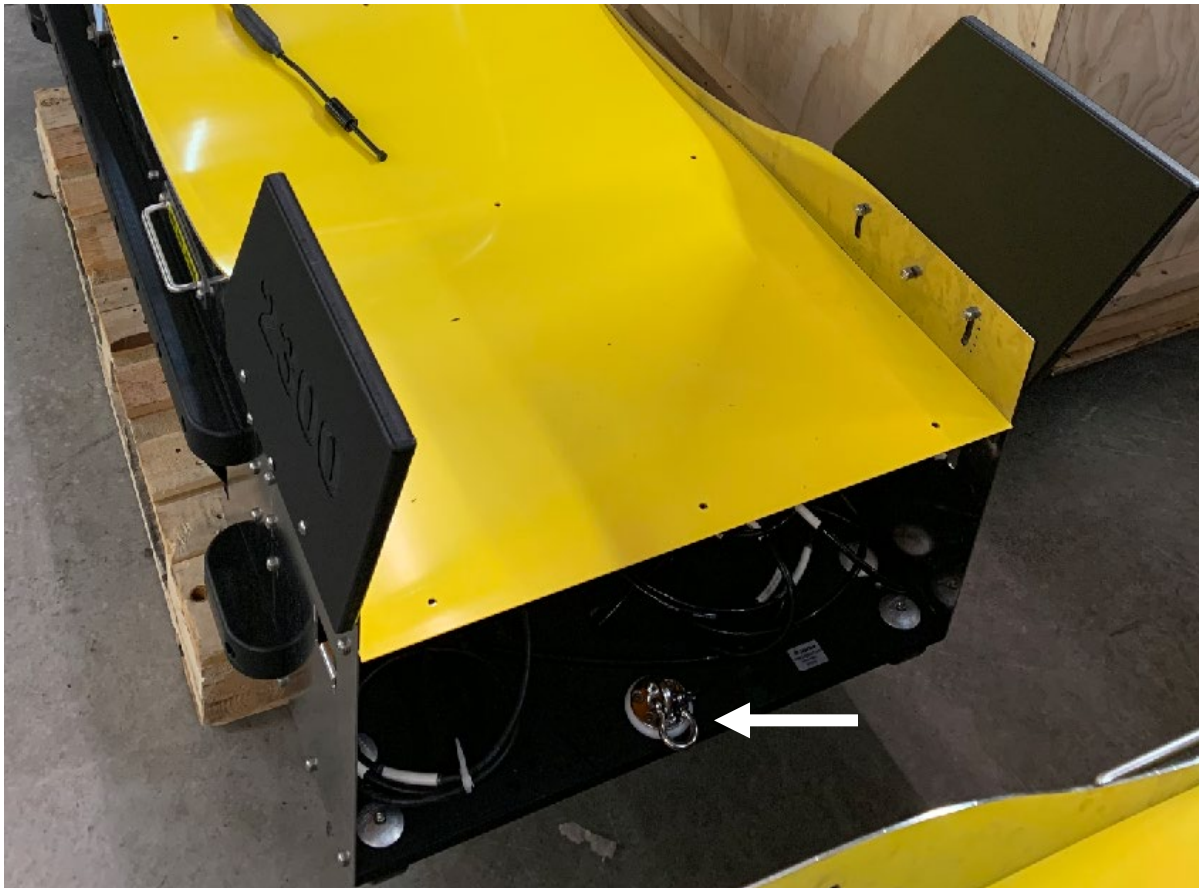

Figure 1-10: 2300 Towfish Magnetometer Shackle

2.0 SPECIFICATIONS

Because the 2300 system is highly-customizable, specifications vary from installation to installation. The tables and drawings provided in this section are specifications for a baseline system configuration; please refer to the provided configuration-specific addendum for information about a particular system purchased.

2.1 Towfish Specifications

Specifications for the 2300 towfish are provided in the table below:

SPECIFICATION	VALUE
<i>Standard System Specifications</i>	
<i>Frequency</i>	Choice of either 120/410/850 kHz or 230/540/850 kHz tri-frequency side scan sonar with any two frequencies operating simultaneously on command
<i>Operating Range (meters/side)</i>	120 kHz: 500m 230 kHz: 230m 410 kHz: 150m 540 kHz: 120m 850 kHz: 75m
<i>Horizontal Beam Width</i>	120 kHz: 0.68° 230 kHz: 0.5° 410 kHz: 0.3° 540 kHz: 0.26° 850 kHz: 0.2°
<i>Resolution Along Track</i>	120 kHz: 2.4 m @ 200 m 230 kHz: 1.3 m @ 150 m 410 kHz: 0.6 m @ 100 m 540 kHz: 0.45 m @ 100 m 850 kHz: 0.18 m @ 50 m
<i>Resolution Across Track</i>	120 kHz: 8 cm 230 kHz: 3 cm 410 kHz: 2 cm 540 kHz: 1.5 cm 850 kHz: 1 cm
<i>Vertical Beam Width</i>	50°
<i>Depression Angle</i>	Tilted down 24°-27°

SPECIFICATION	VALUE
Physical	
<i>Length x Width x Height</i>	205.9cm (81.08in) x 81.7cm (32.17in) x 128cm in (50.41in)
<i>Weight in Air</i>	499kg (1100lbs)
<i>Weight in Water</i>	272kg (650lbs)
<i>Maximum Depth in Water</i>	2000m (6561.68ft)

Table 2-1: Towfish Specifications

MPES BATHYMETRY OPTION			
SPECIFICATION	VALUE		
<i>Frequencies</i>	120 kHz	230 kHz	540 kHz
<i>Beamwidths</i>	1.5° x 1°	1° x 0.7°	1° x 0.5°
<i>Max Sounding Depth below Towfish</i>	150 m	100 m	50 m
<i>Max Swath Width</i>	550 m	400 m	200 m
<i>Sounding Patterns</i>	Equidistant and Equiangular		

Table 2-2: MPES Bathymetry Options Specifications

2.2 Rack Mount Topside Specifications

2.2.1 Rackmount General Specifications

SPECIFICATION TYPE	VALUE
Size (LxWxD)	76.2cm x 76.2cm x 64.9cm (30 x 30 x 23.37in)
Weight	70.31kg (155lbs)
Case construction	PVC
Shipping Container Type	Sealed high impact polyurethane case
Shipping Container Size	76.2cm x 76.2cm x 76.2cm (30 x 30 x 30in)
Operating Temp.	0–45°C (32–113°F)
Storage Temp.	-30–70°C (-22–158°F)
Operating relative humidity	0–95% (non-condensing)

Table 2-3: 2300 Rackmount General Specifications

2.2.2 Rack Mount Topside Computer Specifications

SPECIFICATION TYPE	VALUE
Input Voltage	100-264 VAC, 50/60 Hz, auto-switching
Processor	Intel Core, I7, 3.6 GHz Quad-Core
Memory	4 GB, 1333 MHz
Data Storage	DVD/RW drive 1-TB hard drive (data) 500-GB hard drive (OS)
Display	21-inch LCD Monitor
Keyboard	High impact industrial keyboard
Pointing Device	High impact industrial trackball
I/O Ports	(2) Ethernet Ports (4) Serial COM Ports (6) USB 2 (2) USB 3
Operating System	Windows 10

Table 2-4: Topside Computer Specifications

2.2.3 Rack Mount Topside Starmux IV Specifications

SPECIFICATION TYPE	VALUE
Input Voltage	100-264 VAC, 50/60 Hz, auto-switching
Input Power	~1200w maximum
Power to Towfish	375 VDC
I/O Ports	(4) Ethernet Ports (6) Serial Ports (1) FSK Trigger
Serial Port Pin Configuration	Pin 2= TX to PC Pin 3=RX from PC DCE Pin 3= TX to PC Pin 2=RX from PC DTE Pin 5=Ground
<ul style="list-style-type: none"> Use Straight cable to connect to PC. All serial ports wired as DCE except port #1 wired as DTE. 	

Table 2-5 Topside Starmux IV Specifications

2.3 Optional Cable Specifications

EdgeTech currently sells one 2300 compatible armored cable. If you'd like to purchase, contact [EDGE TECH CUSTOMER SERVICE](#).

2.3.1 Tyco Dataline A302799 Double-Armored Coaxial Tow Cable

SPECIFICATION	VALUE
Construction	Polyethylene, Copper, Polyester, Galvanized Steel
Maximum Length	4500 m (14763.8 ft)*
Weight In Air	469 kg/km (315 lb/kft)
Weight in Seawater	379 kg/km (255 lb/kft)
Specific Gravity	5.4
Breaking Strength	71.2 kN (16,000 lbf)
Maximum Working Load	17.8 kN (4,000 lbf)
Minimum Bend Radius (Dynamic)	23 cm (9.0 in)
Capacitance	131 pF/m (40 pF/ft)
Impedance	40 Ω
Velocity of Propagation	66% nominal

*See TABLES 5.1 THROUGH 5.6 for Cable Paid Out vs. Speed and Depth Charts

Table 2-6: Optional Tyco Dataline A302799 Double-Armored Tow Cable Specifications

2.4 2300 Mechanical Drawings

2.4.1 Towfish Mechanical Drawings

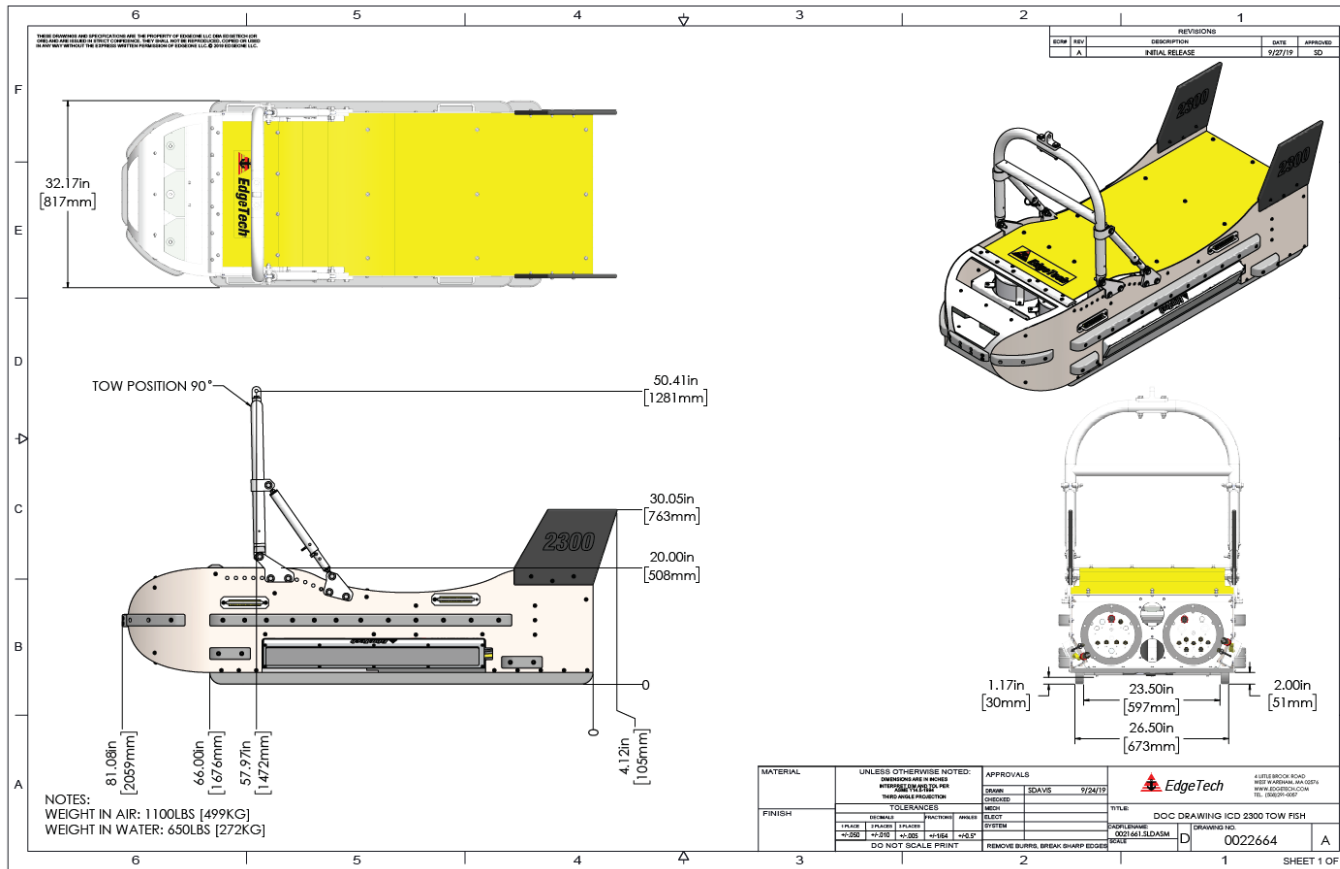

Figure 2-1: 2300 Towfish ICD

2.4.2 Sonar Processor Electronics Bottle

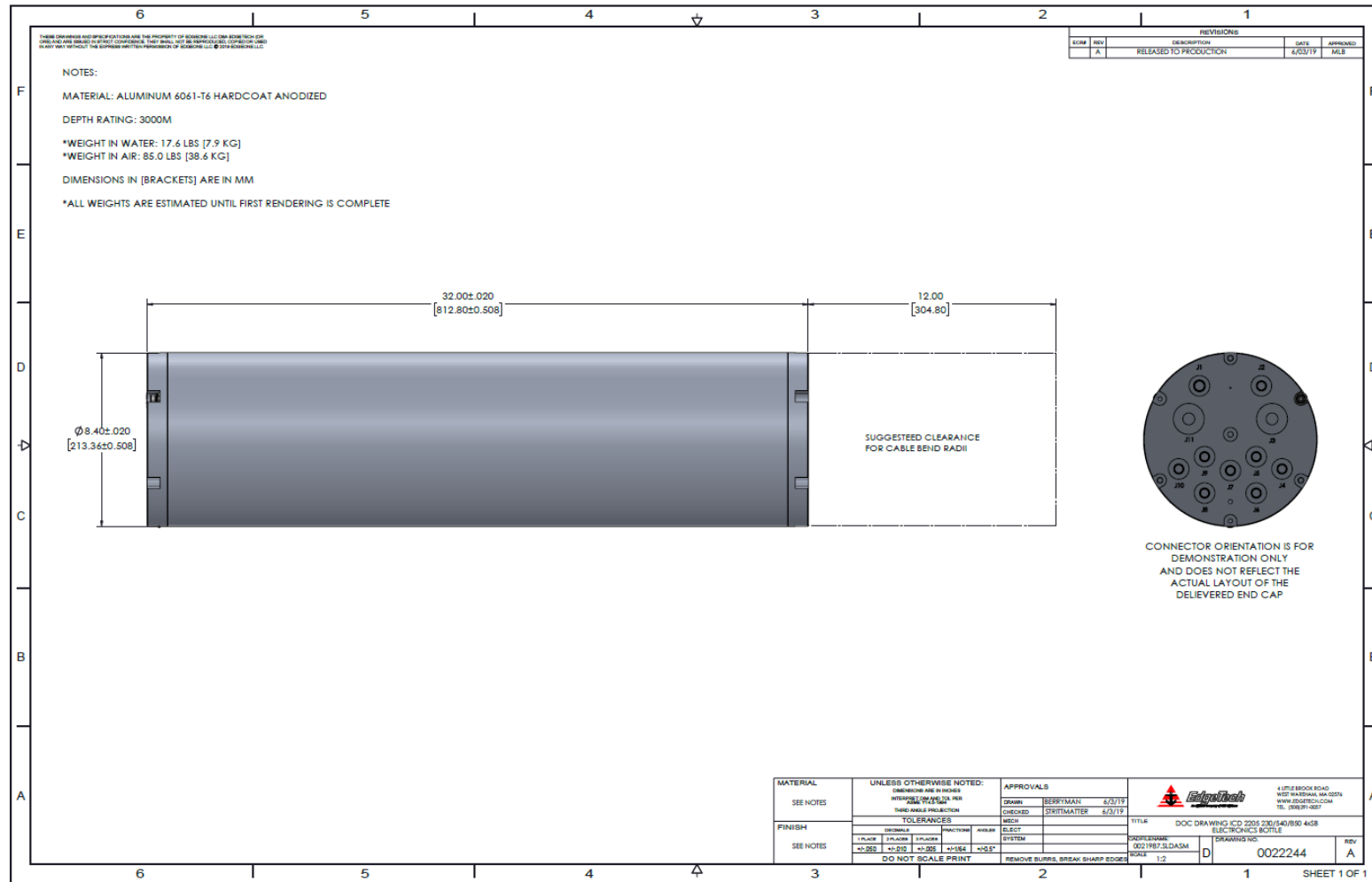

Figure 2-2: Sonar Processor Bottle ICD

2.4.3 Multiplexer Electronics Bottle

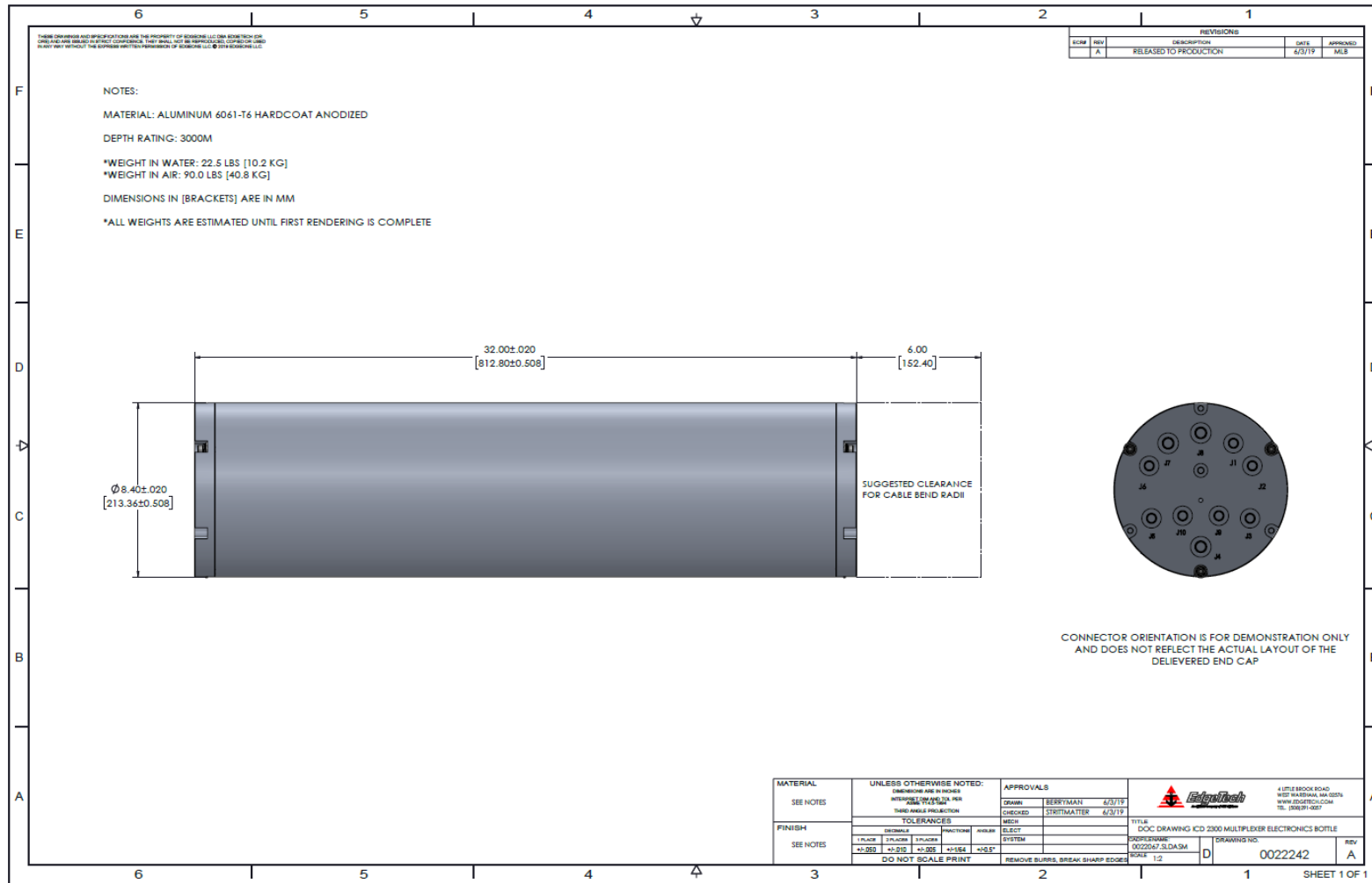

Figure 2-3: 2300 Multiplexer ICD

2.4.4 2300 Rackmount Drawing

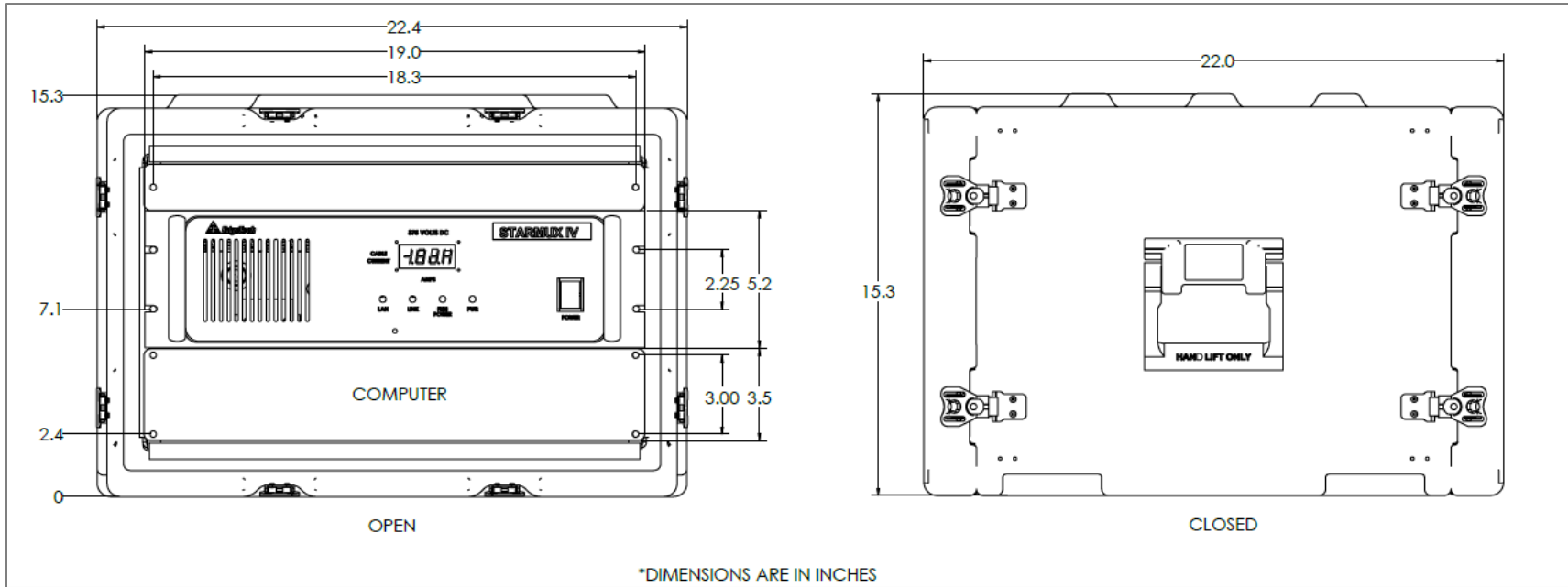

Figure 2-4: 2300 Rack Mount Drawing

3.0 TECHNICAL DESCRIPTION

This section of the manual describes the various internal and external interfaces, connections, and displays of a system. The configuration described is standard, but yours may differ based on the options chosen at purchase. Please refer to the specific EdgeTech System *Technical and User's Guide* provided with your system to learn the specific technical details of your system. Contact Edgetech **CUSTOMER SERVICE** if you cannot find this guide.

3.1 Towfish Technical Description

The 2300 towfish is designed to support a basic configuration consisting of paired side-scan transducer arrays, vertically oriented sub-bottom transducers, PVDF sub-bottom receiver, and laterally oriented sonar processor and multiplexer. The towfish receives power and data from a tow cable that connects to a Starmux IV Topside located on the towing vessel. The sonar processor generates, receives, and processes data from the side-scan and sub-bottom arrays for transfer to the multiplexer. The multiplexer merges available sensor data with the sonar data for transmission to topside Starmux IV. A more specific detailed description of your 2300 and its configuration can be found in the *System Technical and User's Guide* provided with your system.

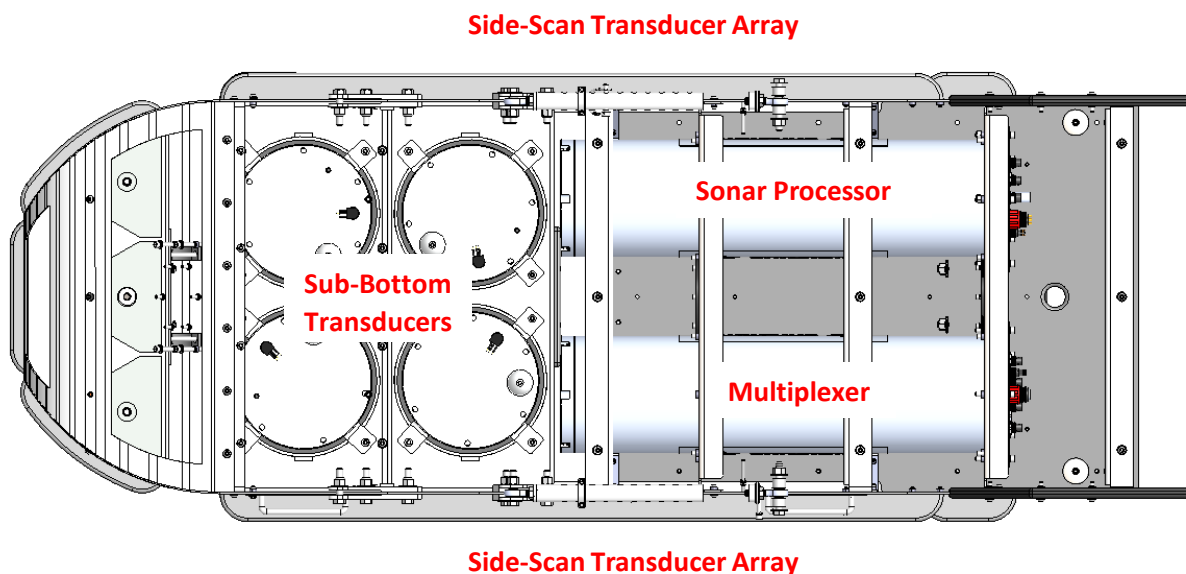

Figure 3-1: 2300 Towfish Top-Down Internal View with Component Callouts

3.1.1 System Connection Diagram

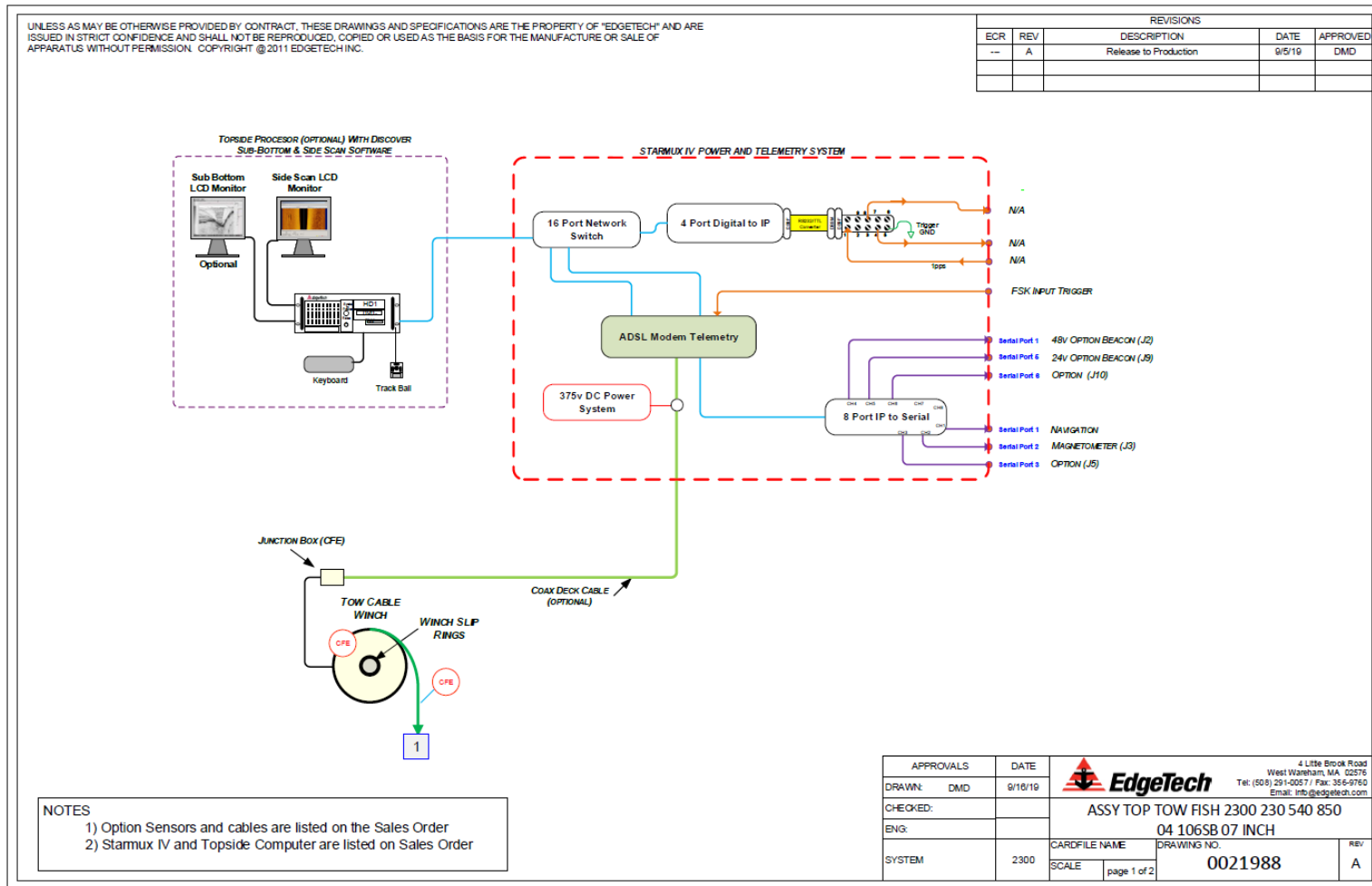

Figure 3-2: 2300 Topside System Connection Diagram

3.1.2 Multiplexer and Sonar Processor Endcap Diagrams

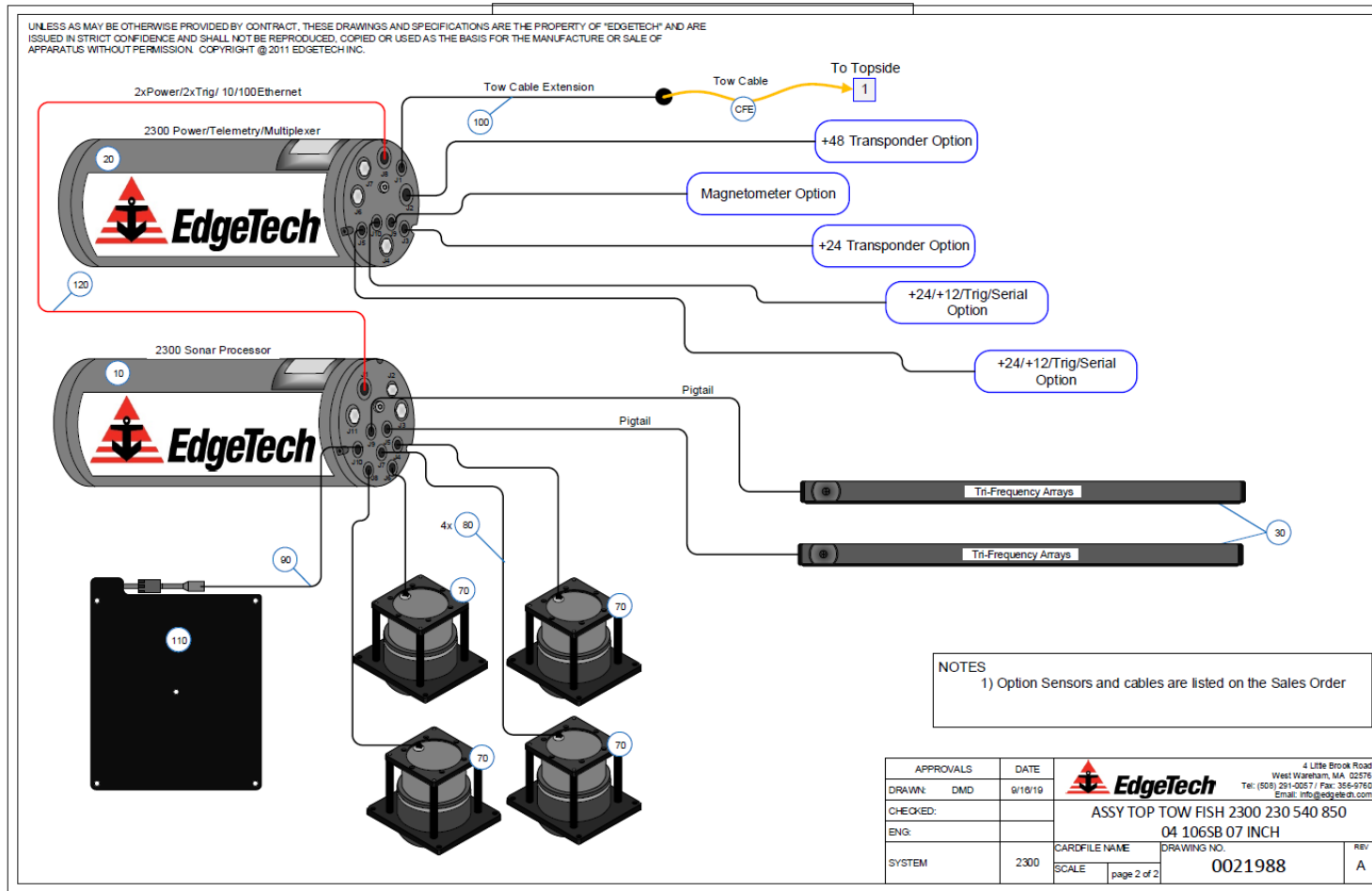

Figure 3-3: 2300 Subsea Hardware Configuration

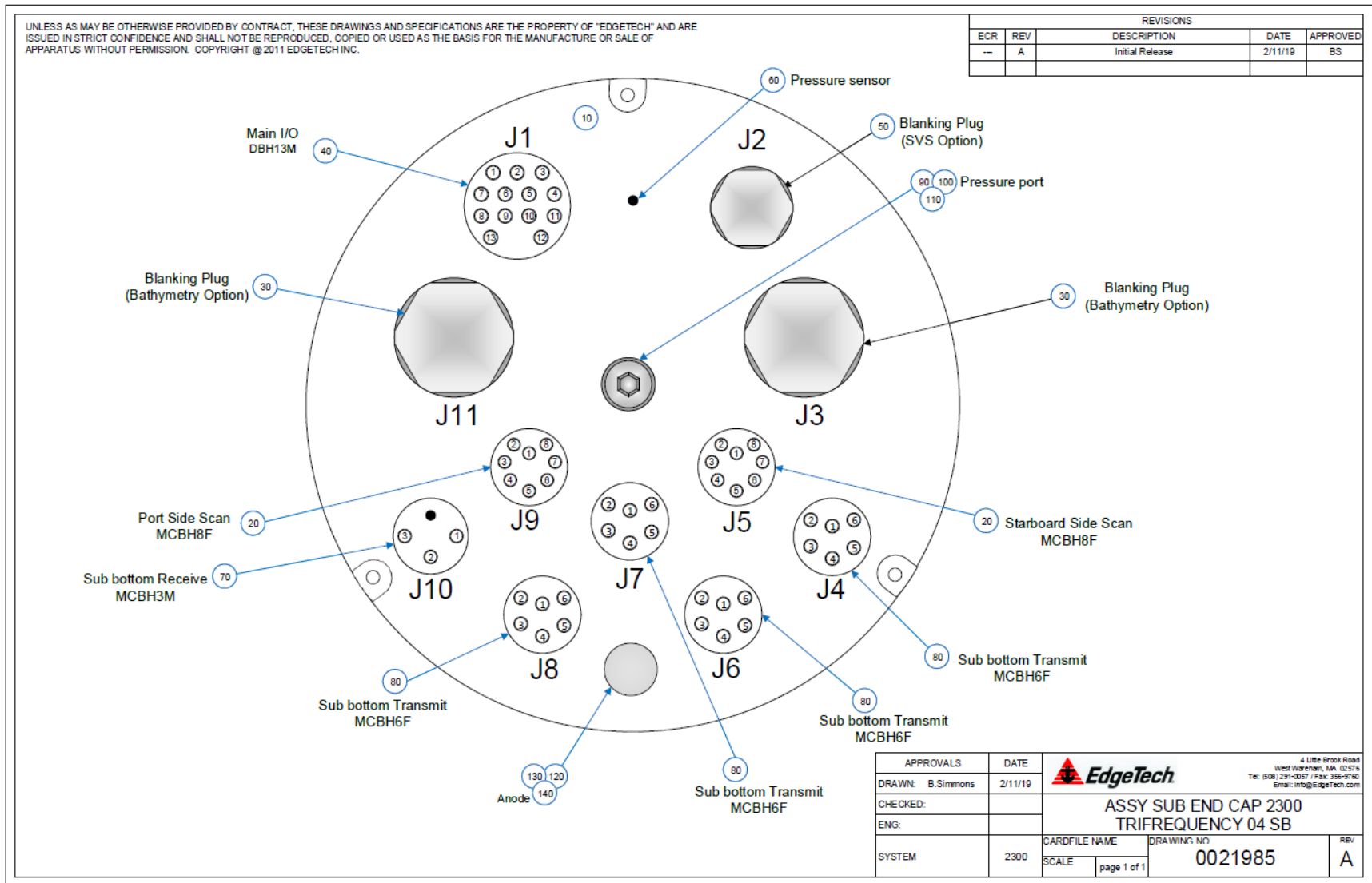

Figure 3-4: Non-Bathymetric Sonar Processing Endcap Drawing

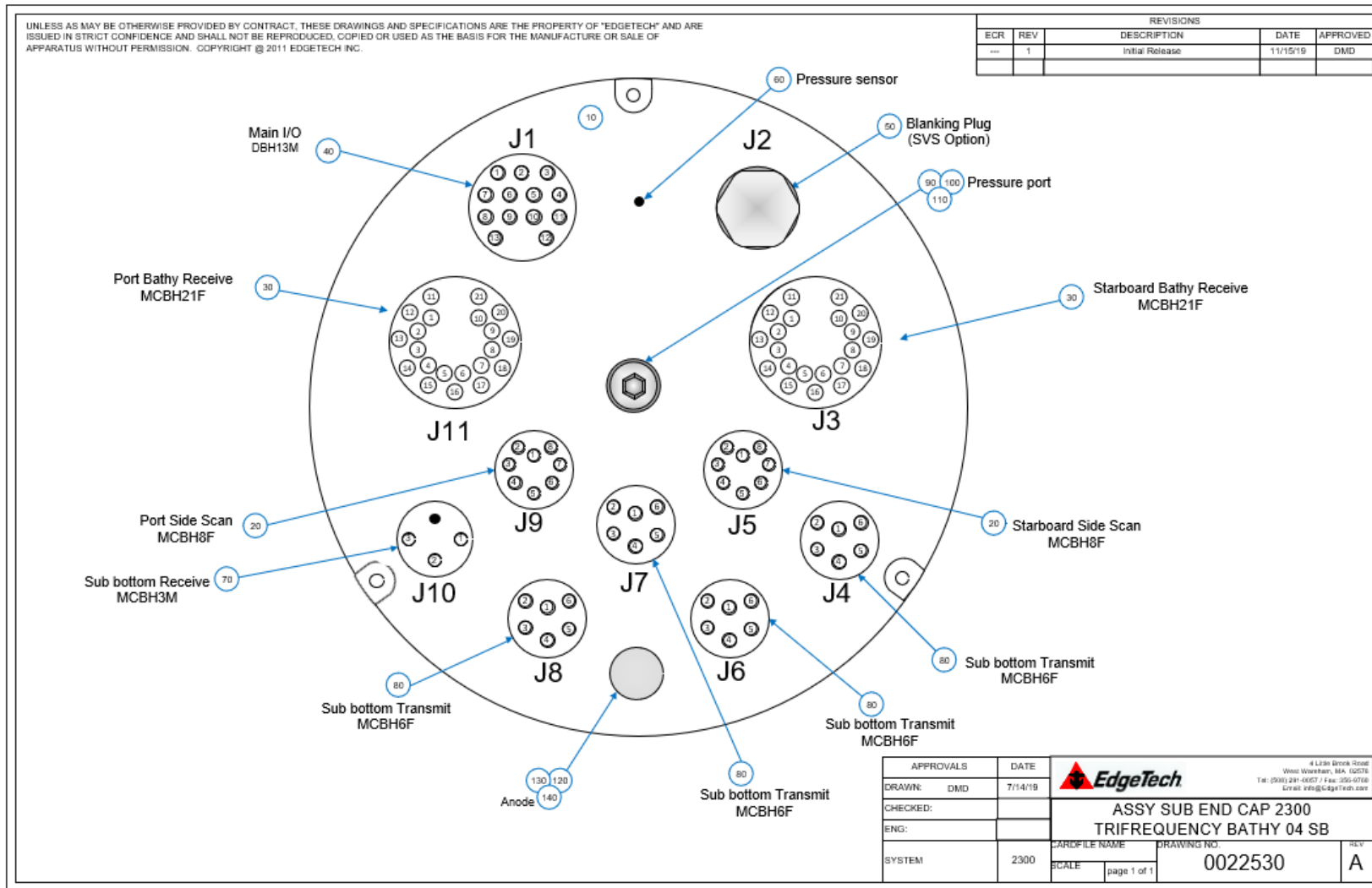

Figure 3-5: Bathymetric Sonar Processor Endcap Drawing

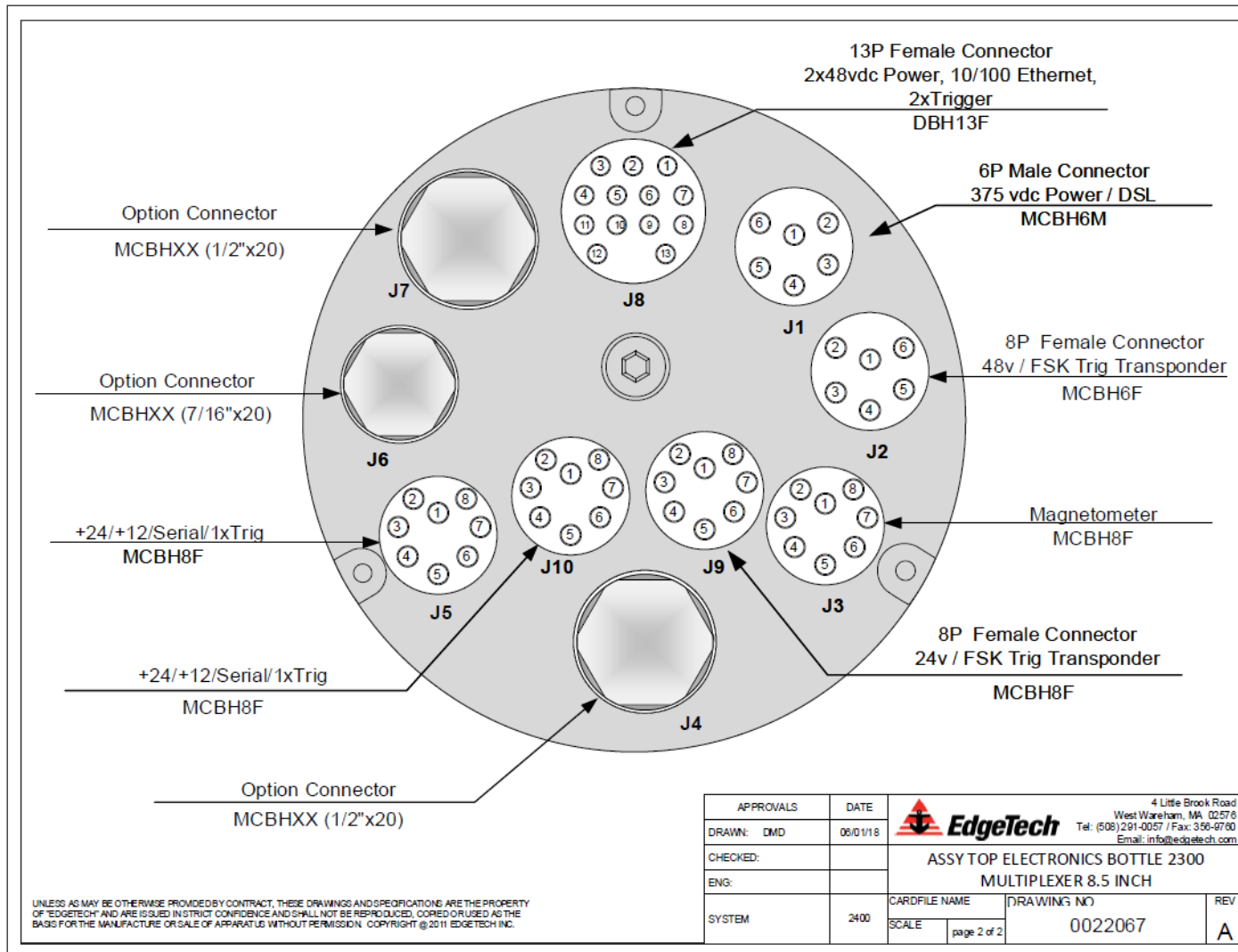

Figure 3-6: 2300 Subsea Multiplexer Endcap Drawing

3.1.3 Cables

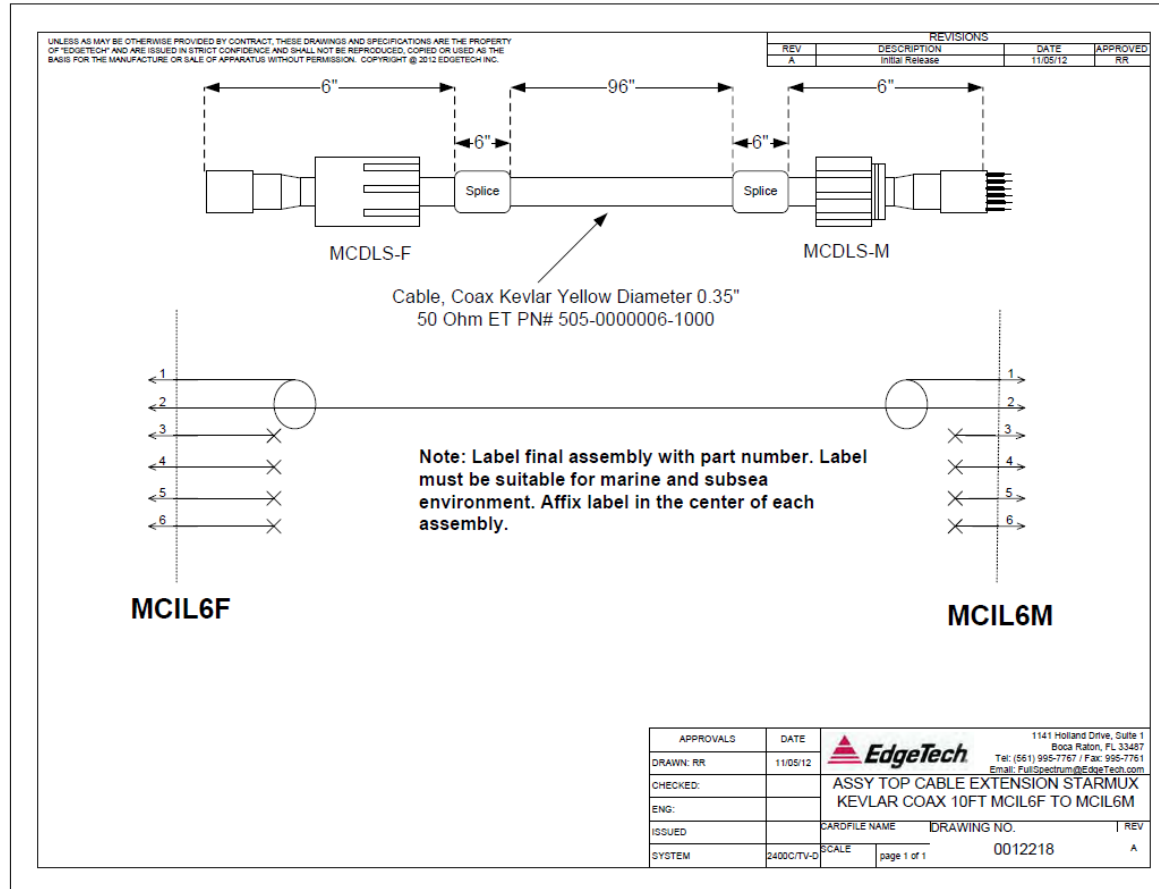

Figure 3-7: MCIL6F to MCIL6M Extension Cable

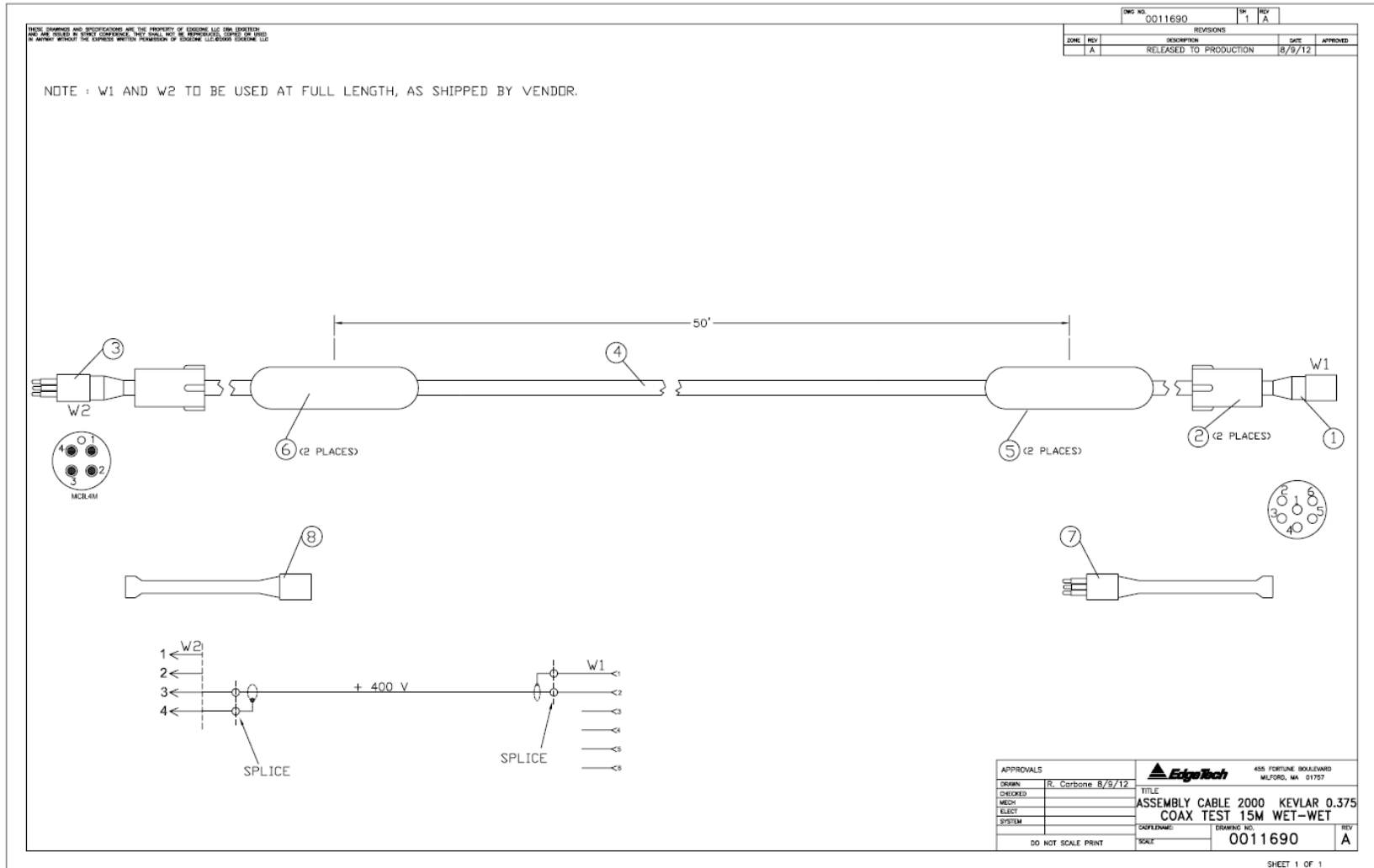

Figure 3-8: Test Cable

3.2 Rack Mount Topsiside Technical Description

The Starmux Rack Mount includes an EdgeTech configured PC with a display, trackball mouse, keyboard, and a Starmux IV digital telemetry link, all housed in a rugged case. The PC has a Windows operating system and Edgetech's Discover Software application installed and configured for use. The Starmux IV digital link provides power to the towfish while acting as a digital link between the towfish and a topside computer with the Discover application on it to process and record sonar data. The digital link also provides input connections for supporting survey, navigation devices, and triggers.

3.2.1 Starmux IV Controls, Indicators, and Connections

FRONT PANEL STARMUX IV	
Starmux IV Power Switch	Rocker switch. Turns the Starmux Digital Link on or off. The rear line power switch needs to be turned on for this switch to function.
LAN Indicator Light	Green indicator. Flashes continuously when an Ethernet connection is established.
LINK Indicator Light	Green indicator. Flashes while the Starmux Digital Link is establishing a reliable communications link with the side-scan sonar. Illuminates continuously when a reliable communications link with the sonar is established.
Fish Power Indicator Light	Red indicator. Illuminated when the Starmux Digital Link is, and the side-scan sonar is on.
PWR Indicator Light	Green indicator. Illuminated when the Starmux Digital Link is on.
Digital Display	Display the current Starmux system voltage
BACK PANEL STARMUX IV	
Line VAC Connector	Connection for the AC power cord.
Line Power Switch	Rocker switch. Switches AC power to the POWER switch on the front panel of the Starmux Digital Link.
AC Fuse	AC fuse
GND Lug	Electrical grounding lug for Sea Ground.
Network Ethernet Connectors (4)	RJ-45 Standard Ethernet connection for connecting to the external topside processor.
FSK Sync Connector	Input data connector for a FSK beacon external trigger.
Fuse	2.5A replaceable fuse
Sea Cable Connector	Sub Conn MCBH4F female connector to sea cable going out to tow vehicle.
1PPS Connector	Pulse per second connector.
Trigger Connectors (2)	Optional digital ports are provided for triggers.
Serial Com Ports (6)	Serial ports for external device connections.

Table 3-1: Starmux IV, Indicators, Connections

3.2.2 Computer Controls and Connections

FRONT PANEL COMPUTER	
USB Connectors	(2) USB connectors.
DVD Drive	DVD\RW drive.
BACK PANEL COMPUTER	
Line VAC Connector	CEE-type AC input connector.
Power Switch	Rocker switch. Turns the 2U-CPU computer on or off.
USB Connectors	(4) USB connectors
Ethernet Connector	RJ-45 connector
Video card	Video card with 4 Mini DP (Display)Connectors. Provides video display to the monitor.
COM-1 NAV Connector	DB-9 female connector. RS-232 serial port that connects to the navigation system when the Starmux IV is not used.
COM-3 Connector	DB-9 female connector. General-purpose RS-232 serial port.

Table 3-2: Computer Controls and Connections



Figure 3-9: Labeled Front Panels of 2300 Rackmount

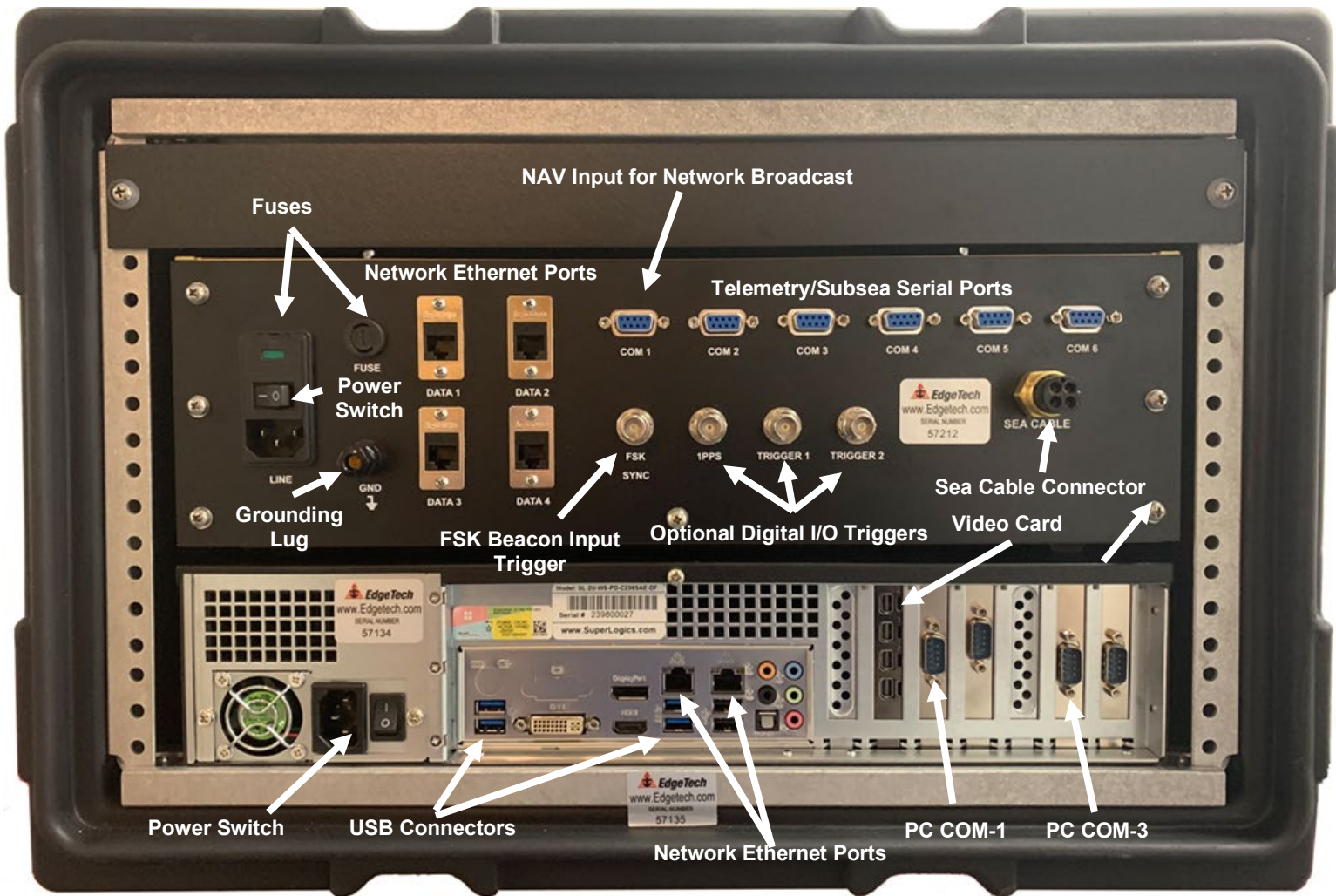

Figure 3-10: Labeled Rear Picture of 2300 Rackmount

4.0 SYSTEM SETUP

The setup and test of the EdgeTech 2300 system involve unpacking, inspecting, and connecting the system components. These connections include not only the power and tow cables but also any optional equipment such as printers, navigation systems, and external sonar systems.

This section also explains how to activate and test the system using the EdgeTech Discover software, along with providing instructions for deployment and recovery of the towfish. For detailed information about the Discover software, refer to the corresponding Discover 2300 software manual.

4.1 Unpacking and Inspecting

The 2300 is shipped with care. The towfish is shipped in a reusable wooden crate, the 2300 Rack Mount Topside is shipped in a reusable heavy-duty transport case, and the supplied set-up cables and documentation are shipped in heavy-duty shipping cartons.

Before unpacking the system components, inspect the shipping containers for any damage. Report any damage to the carrier and to **EDGE TECH CUSTOMER SERVICE**. If the shipping containers appear free of damage, carefully unpack the components and inspect them individually for damage. Again, if any damage is found, report it to the carrier and to EdgeTech. Also, check the packing list to verify that all the items on the list are included. If any items are missing, immediately contact EdgeTech. **Do not** install or operate any equipment that appears to be damaged.

Although the items shipped will vary depending on the customer requirements, the system typically includes, at a minimum, the items listed below for each topside processor.

For a standard system that includes a 2300 Rack Mount Topside Processor:

- 2300 Rack Mount Topside Processor
- 2300 Towfish
- Monitor
- Keyboard
- Trackball
- AC power cords (2)
- Video cable
- Software CDs
- System Restore to Factory Default Image on Flash Drive

After unpacking the system components, safely store the shipping containers, including any packing materials for later use. When transporting or storing the system, pack all items in their original shipping containers, and in the same way they were initially shipped. Store the system in a dry environment when not in use.

4.2 Towfish Bridle Adjustments for Towing, Movement, and Transport

The towfish bridle position and angle should be adjusted for towing, movement, and transport.

4.2.1 Adjusting Bridle Strut Position for Towing Movement and Transport.

Adjusting the bridle position involves removing [2] locking pins and unthreading [4] hex screws on the [2] support struts of the bridle, adjusting the strut position, and then tightening all hex screws and attaching the locking pins.

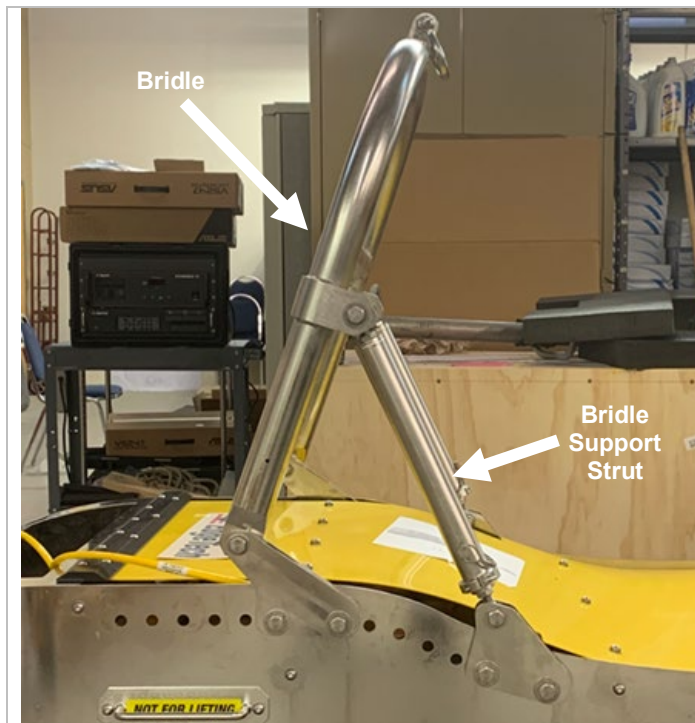

Figure 4-1: Towfish Bridle

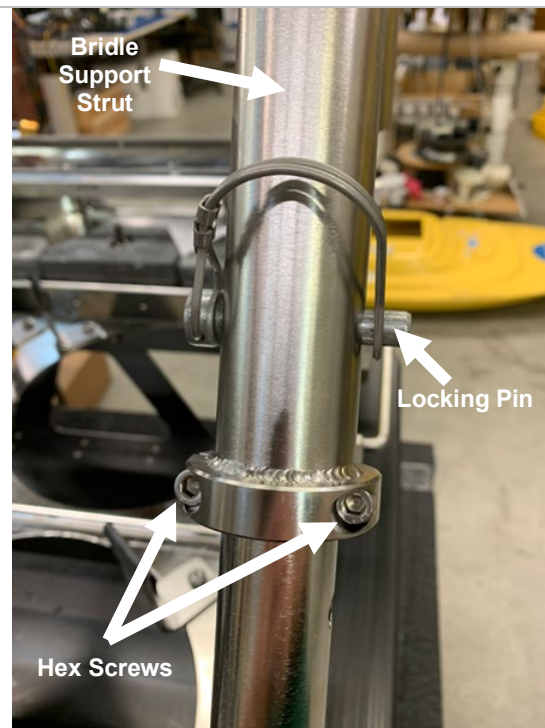

Figure 4-2: Support Strut

Tools:

- 3/16" hex head screwdriver or 3/16" Allen wrench

Instructions:

1. Remove locking pin from bridle support strut by pulling wire lock away from pin end and pulling the pin completely out of the strut
2. Unthread (2) hex bolts from support strut using a hex screwdriver.



Figure 4-3: Bridle Support Strut Adjustment

3. Repeat steps 1 and 2 on the strut on the other side of the bridle.
4. Adjust the bridle position by pushing and pulling the bridle to the desired angle.
 - **Towing Position:** The bridle should be positioned at 90° relative to the towfish.



Figure 4-4: 90° Bridle Position

- **Winch or Crane Movement Position:** The bridle should be positioned at $\sim 80^\circ$. This position provides angle leverage for movement on a crane or winch that is safer for towfish systems.

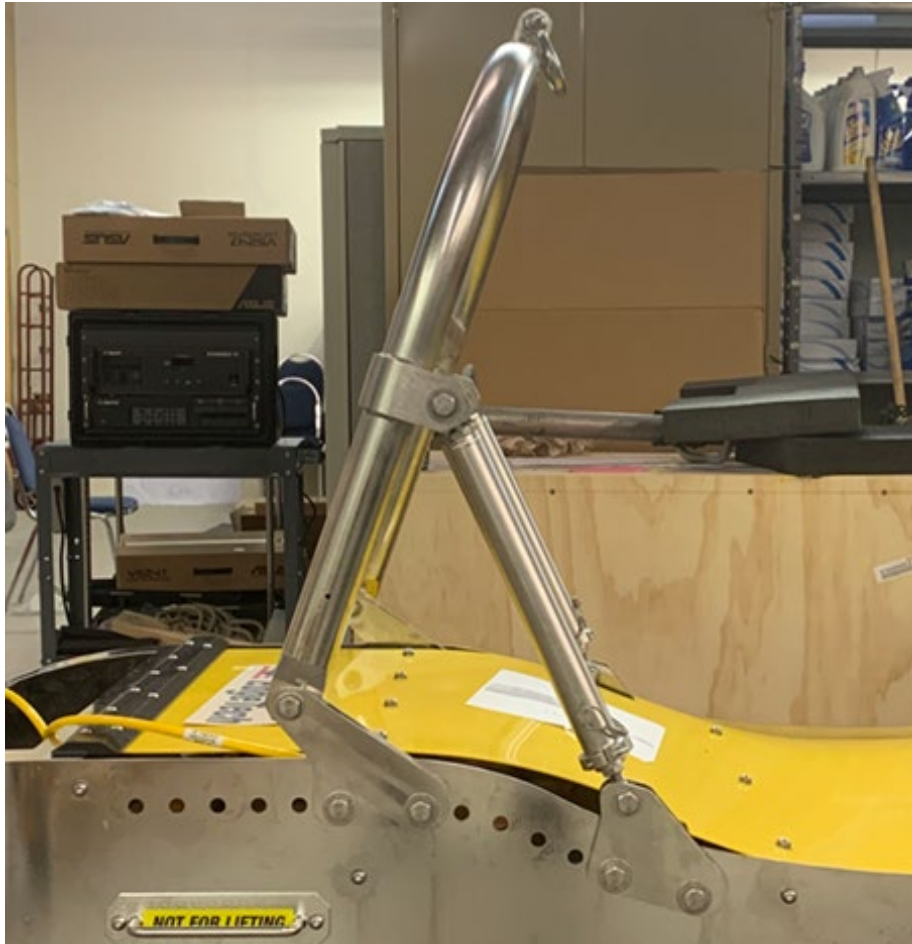

Figure 4-5: Bridle Winch or Crane Movement $\sim 80^\circ$ Position

5. Once positioned, rethread the hex screws with the hex screwdriver and reinstall the locking pins on each side of the bridle.

4.2.2 Configuring the 2300 for Shipping and Transport

Great care should be taken when shipping or transporting the 2300 tow vehicle. The vehicle is ruggedly designed, but excessive impacts can damage the towfish vehicle or electronic components contained within. If possible, use the original crating and packaging provided with your system as they have been designed to transport the towfish vehicle. If these are no longer available, try and replicate the original configuration as much as possible. If you have any questions, contact **CUSTOMER SERVICE** for support.

Tools Required:

- [7] 2x4 pieces of wood
- 3/16" hex head screwdriver or 3/16" Allen wrench
- Powered winch or crane.
- Drill with screwhead bit.
- [24] long carpentry screws

Instructions:

1. The bridle should be at the $\sim 80^\circ$ for transport, as described in the previous section, **ADJUSTING BRIDLE STRUT POSITION FOR TOWING AND MOVEMENT**.



Figure 4-6: Bridle at $\sim 80^\circ$ Position For Crating and Transport

2. Install [3] 2x4 pieces of wood at the bottom of the crate to support the vehicle. One 2x4 should be forward supporting the front end of the towfish. Two should be installed stacked at the rear flush against the crate to restrict lateral movement. Secure using carpentry nails.
3. Install padding at the bottom of the shipping crate.
4. Carefully lift and set towfish vehicle on top of support forward 2x4 and padding. The vehicle should be against the rear stack of [2] 2x4 to restrict lateral movement.
5. Install [1] 2x4 piece of wood on both port and starboard sides, parallel to the vehicle. Make sure the wood is snug against the side of the padding below the towfish to restrict lateral movement. Do not secure against transducers. Secure the 2x4s to the bottom of the crate using carpentry nails.

6. Install [1] 2x4 over the forward section of the vehicle along the black rubber mounting strip. It can be rested on the vehicle. Secure to shipping crate using carpentry screws. The objective is to restrict the vertical movement of the towfish.
7. Install [1] 2x4 over the mid-section of the tow vehicle. It can be rested on the vehicle. Secure to shipping crate using carpentry screws. The objective is to restrict the vertical movement of the towfish.

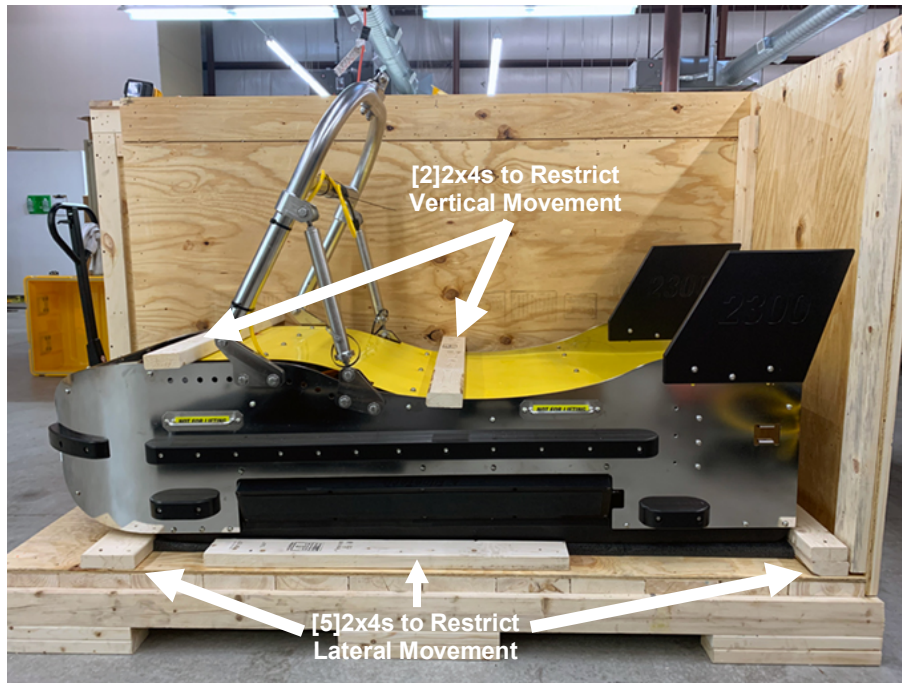

Figure 4-7: 2x4 Installation in Crating to Restrict Vertical and Lateral Movement

8. Complete the crating of the vehicle by installing the remaining sides. Secure the two top 2x4s to the newly installed crate siding by driving carpentry screws through the crating and into ends of the installed 2x4s.

4.3 Power Requirements

The power requirements for the 2300 Series Topside processor are 90–260 VAC, 50/60 Hz, and is auto-switching.

4.3.1 Use of an Uninterrupted Power Supply

The AC power source should be continuously free of high-amplitude, high-frequency transients, as this type of interference could degrade performance or damage the equipment. An uninterrupted power supply (UPS) with power surge protection is recommended for powering the equipment. However,

whether a UPS is used or not, do not use the same AC power source as one being used to power electric motors on the survey vessel, such as pumps and winches. Do not use switching type battery chargers or DC to AC converters with square wave outputs.

4.3.2 Changing to a Non-US Power Plug

An AC power cord is provided for connecting the Deck Unit to a standard U.S. 3-pronged outlet. For non-U.S. power outlets, users can modify this cord by cutting off the 3-pronged plug and attaching the appropriate plug.

AC POWER CORD WIRE COLOR	FUNCTION
Black	AC line
White	AC neutral
Green	Earth ground

Table 4-1: AC Power Cord Wiring

4.4 Navigation Interface

The 2300 Series accepts all standard National Marine Electronics Association (NMEA) 0183 message sentence formats and others from a connected global positioning system (GPS) or integrated navigation systems. The devices may either be a payload on the towfish or connected to the topside on the vessel. Refer to the 2300 Software Manual for GPS configuration information. If EdgeTech installed a navigation device on the towfish, refer to the Technical Manual and User's Guide you received with the towfish for configuration details. Please do contact **CUSTOMER SERVICE** if you have any specific questions on configuration and message formats.

The Starmux IV is configured to accept navigation data on Serial Port #1 and, in turn, broadcast this data using the Starmux IV IP address at Port 10001. The serial port is wired as DTE, where Pin 2 Receives data FROM a Device, and Pin 3 Transmits data TO a Device. If Navigation data is coming from a GPS unit (DCE), only a straight (pin-to-pin) cable is required to connect the GPS (DCE) to the Starmux IV Serial Port #1 (DTE). Connecting the Navigation data to the Topside PC will make the data available to Discover, but it will not be recognized by the Starmux IV telemetry system. Programs such as TerraTerm can be used to verify that the GPS data is on the network by monitoring IP Address 192.9.0.201 at Port Location 10001.

4.5 Topside Processor Placement

The 2300 Rack Mount Topside should be located and set up in a dry, sheltered area that is protected from weather and water spray. The unit also requires an environment where the temperature is consistently between 0°C and 40°C (32°F and 104°F).

Furthermore, avoid areas of direct sunlight, especially in tropical environments, as heat buildup could damage the equipment, and glare could hinder the user's ability to see LCDs, digital displays, and status indicator lights. The location of the processor should also allow users to communicate directly with the deck crew that is handling the towfish.

Secure the topside processor in place, using tie-downs if necessary, near the required AC power source. Also, ensure that there is ample room behind the rack for connecting the cables. Support the components inside the rack using appropriate mounting brackets and secure the front panels using standard 19-inch rack front panel mounting hardware.

4.6 IP Address Settings

The 2300 system includes many Ethernet devices connected to a common local area network (LAN). Each of these devices has a factory set IP address that, under normal circumstances, does not require changing. However, should any of these devices be replaced, or if upgrades are later installed, the IP addresses may need to be reconfigured. In addition, any computer that is to be connected to the 2300 Topside Computer or the Starmux IV Digital Link must have its IP address set to 192.9.0.nnn, where nnn is any integer from 1 to 255—except for the following reserved addresses:

- 192.9.0.201- Topside 8-Port Serial-to-IP Converter
- 192.9.0.203 Topside 4-Port Digital-to-IP Converter (future)
- 192.9.204 Subsea 10-Port Web Power Relay
- 192.9.0.205 Subsea 8-Port Serial to IP Converter
- 190.9.0.207 Subsea 4-Port Digital-to-IP Converter (future)

The factory IP address setting of the wired Ethernet connection for the computer included with the 2300-Rack Mounted Topside Processor is 192.9.0.102, and for the Subsea Sonar Processor is 192.9.0.101.

4.7 Connecting the System Components

All the system components, including optional components, such as a printer or additional displays, connect to the topside processor. An example of a fully connected system is shown in the **SYSTEM CONNECTION DIAGRAM (FIGURE 3.2) FOUND IN MANUAL SECTION 3.1.1.**

4.7.1 Connecting the Starmux IV to a Computer

The Starmux IV Topside digital link and computer are connected by an ethernet cable, as shown in **FIGURE 4-8.**

NOTE The ethernet cable must be plugged into the right side ethernet port on the computer and any one of the data ports on the Starmux IV.

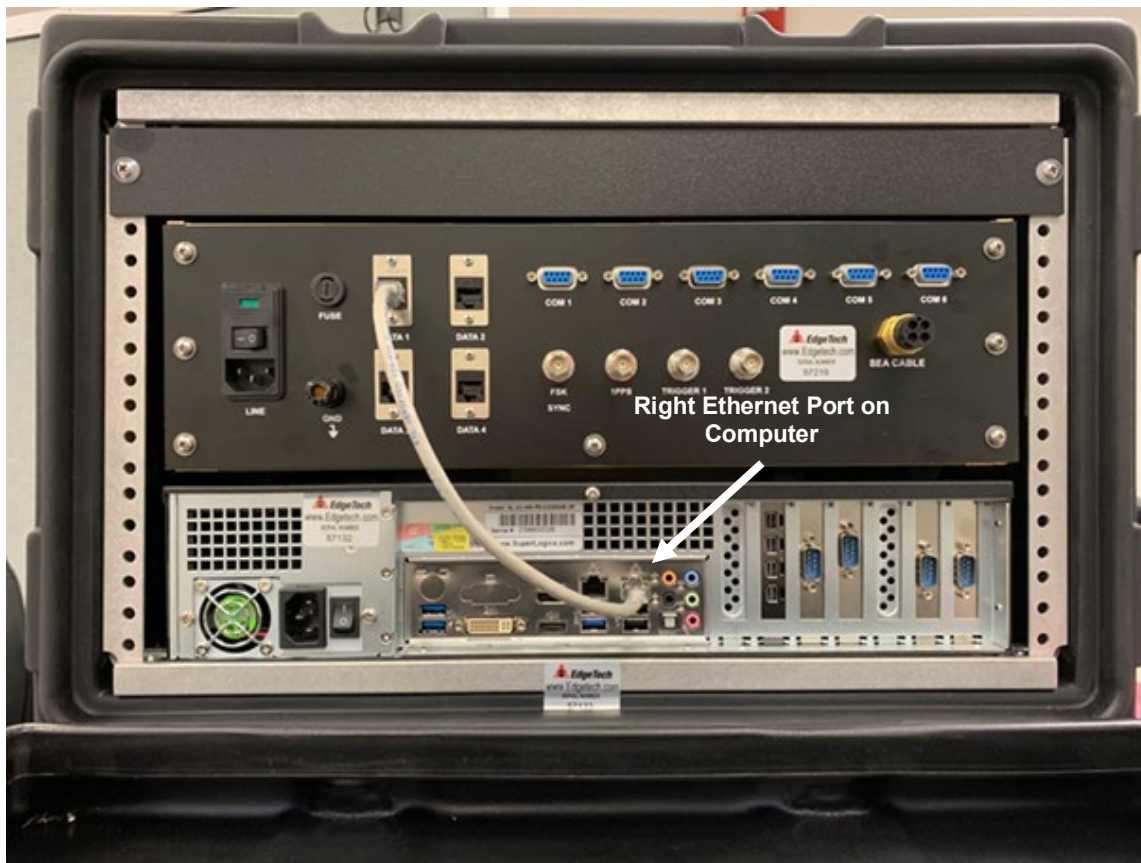

Figure 4-8: Starmux IV and Computer Connected By Ethernet Cable

4.7.2 Connecting and Attaching the Tow Cable to the Towfish

- A tow winch with a slip ring should be used with tow cable to tow the vehicle as displayed in the **SYSTEM CONNECTION DIAGRAM (FIGURE 3.2) FOUND IN MANUAL SECTION 3.1.1.**
- The armored tow cable termination should be connected via a D-Ring to the Shackle at the top of the towfish bridle.
- The cable from the termination should be managed down and secured to the bridle arm with cable ties. Be sure to provide enough slack in the data line so as not to be load-bearing.
- The termination cable should be connected to the towfish extension cable.

4.7.3 Connecting the Tow Cable to the Starmux IV

WARNING! Do not connect the tow cable to the topside processor before connecting it to the towfish. Injury or death can occur if the exposed connector on the tow cable is energized. Always connect the tow cable to the towfish first.

The tow cable connector is connected to the Sea Cable port on the rear panel of the Starmux IV.



Figure 4-9: Starmux IV Sea Cable Connector

4.7.4 Connecting An Optional Magnetometer

An optional magnetometer connects to the 2300 system by plugging it directly into the Telemetry Multiplexer's J3 port (see [FIGURE 3-6](#)) and securing it with the Magnetometer Shackle (see [FIGURE 1-10](#)). This connection provides power to the magnetometer and a serial data interface to the multiplexer that telemeters its data output to the Starmux IV interface, where it is made available on the Starmux IV Serial Port #2. To receive data on the computer, a straight (pin-to-pin) serial cable must be run from Serial port #2 to a COM port on the PC. All Starmux IV serial ports are wired as DCE (Data Communications Device) such that only a straight cable is needed (not a null-modem) to connect to a PC (DTE-Data Terminal Equipment). The exception to this is Serial Port #1, as it is defined to accept a NEMA string from a GPS device. It is wired as a DTE interface, so a null modem is NOT required.

Note: The magnetometer hardware telemetry link is not part of the topside computer system, so hardware parameters (ex. Baud Rate) cannot be modified using the Windows Operating System. To configure, refer to the instructions found in the *Technical and User's Guide* provided with your system.

5.0 ACTIVATION, TEST, AND DEPLOYMENT

After the connections to the topside processor have been completed, the 2300 system can be activated. However, a few pre-deployment checks are required before the deployment of the Towfish to verify that the system is operating properly.

When performing the system activation and test, refer to sub-section, **STARMUX IV DIGITAL LINK TECHNICAL DESCRIPTION** for the location and description of the controls and indicators on the topside processor. Should the system not activate properly or the pre-deployment checks fail, refer to the **TROUBLESHOOTING** section of the manual for assistance on how to isolate and correct the problem.

5.1 Activating a 2300-Rack Mount System

To activate the 2300-Rack Mount:

1. Turn on the 2U Computer and launch Discover.
2. Turn on the LINE switch on the back panel of the Starmux IV Digital Link. This switch can always be left in the "ON" position if desired.
3. Turn on the Starmux IV POWER switch on the front panel.

The Starmux FISH POWER indicator light should illuminate, the LAN indicator should flash continuously, and the LINK indicator should flash while a reliable communications link with the Towfish is being established and then illuminate continuously when the link is found. This may take 1-2 minutes for the modems to connect.

The Starmux IV LED display depicts the current being drawn by the subsea electronics from the 375vdc power supply. This value will vary based on the amount of tow cable being used. When power is first applied, all subsea systems are inactive EXCEPT, the Multiplexer's internal housekeeping functions. The LED display should show a nominal current draw of 230mA.

4. Open Internet Explorer once the topside computer is operational. All web-accessible device configuration pages should have an Internet Explorer Tab set up, can also be found under the Favorites' Menu, or can be accessed by typing their IP address. If the Subsea components are not active or fully booted, a specific tab may show "No Device Found" or "Address Not Accessible." In these instances, click the refresh icon in Internet Explorer to reload the web page.
5. To activate any of the Subsea hardware, the components must be turned ON via the Power Supply Relay (WebRelay) web interface (**FIGURE 5-1**). From here, you can activate each desired device. Refer to the various device Appendices for the serial Diagnostic displays that will show which device is Transmitting (TX) data from the Subsea and Receiving (RX) data at the Topside.

WebRelay-10		
2205 SONAR (J8)	OFF	<input type="checkbox"/> ON <input type="checkbox"/> OFF
2205 SB AMPS (J8)	OFF	<input type="checkbox"/> ON <input type="checkbox"/> OFF
48v Beacon (J2)	OFF	<input type="checkbox"/> ON <input type="checkbox"/> OFF
reserved	OFF	
Option (J10)	OFF	<input type="checkbox"/> ON <input type="checkbox"/> OFF
Magnetometer (J3)	OFF	<input type="checkbox"/> ON <input type="checkbox"/> OFF
24v Beacon (J9)	OFF	<input type="checkbox"/> ON <input type="checkbox"/> OFF
Option (J5)	OFF	<input type="checkbox"/> ON <input type="checkbox"/> OFF
reserved	OFF	
reserved	OFF	
Mux Temp	25.1 °C	
Current Time: Thu, 01 Jan 1970 00:22:42		

Figure 5-1: WebRelay Control Interface

6. The 2205 Sonar Processor electronics are controlled via TWO selections on the WebRelay Screen.
 - The 2205 electronics and Tri-Frequency/Bathymetric arrays are controlled through the “2205 SONAR (J8)” selection.
 - If Sub-Bottom is required, the selection labeled “2205 SB AMPS (J8)” must also be activated. Turn “ON” the POWER switch on the front panel.
7. The remaining devices can be activated as needed by turning the devices “ON.” If an OPTION connector is not used, it is recommended that power NOT be applied to this bulkhead.

Note: When the system is power cycled, all relays will return to their default OFF state. This is a precautionary configuration where the user must choose the systems to activate and to have the ability to isolate any malfunctioning component.

By default, the Discover Application should launch at start-up to show the Sidescan and Sub-Bottom displays. Once the 2205 has been enabled in Web Relay Discover's NET Status Tab in Status Indicator Bar in the lower control panel should display **NET: ON**.

8. At this point, the subsea multiplexer is operational, but no hardware or sonar is active. As noted above, to operate the sonar or perform any pre-deployment checks, the operator must turn ON the 2205 electronics, sub-bottom amplifiers, or any of the external sensors before any checks can be performed.

Note: It is recommended that the WebRelay display (**FIGURE 5-1**) always be visible to the operator as a means of confirming that a given system is powered ON.

5.2 Performing System Pre-Deployment Testing

It is good practice to test that the subsea processor is active and error-free, followed by a test of each sonar subsystem before deployment. Instructions on how to do so are provided in the manual sections below.

5.2.1 Testing the Sonar Processor

Testing the Sonar processor involves performing a network ping test to ensure connectivity between the topside and sonar processor and then remoting into the processor's computer and checking the SONAR.EXE application for errors. Enable the sonar processor in Web Relay before performing any test.

To perform the network ping test.

1. Open Windows command prompt on the topside computer.
2. Type PING 192.9.0.1 -t into the prompt. This sends a ping command to the towfish.

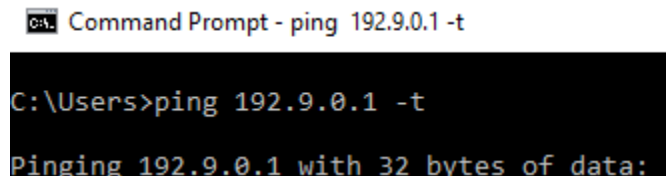

```
Command Prompt - ping 192.9.0.1 -t
C:\Users>ping 192.9.0.1 -t
Pinging 192.9.0.1 with 32 bytes of data:
```

Figure 5-2: Command Prompt Ping Test

- If at any point you want to stop the ping command, press ctrl+c on your keyboard.
- If you receive a response, then there is an active connection.
- If a "request timed out" message is displayed, there is an issue with the network connection.

- Close the Command Prompt Application when complete. If successful, proceed to remoting to the sonar processor for the next test.

To remotely connect to the Sonar Processor in the Towfish.

1. Locate and launch Window's Remote Desktop Application on the connected Topside Computer.
2. Once launched and connected to the Processor's computer, look for an open Sonar.exe window on the upper left side of the remote desktop display (see [FIGURE 5-4](#)). Check to be sure the Self Test Value is listed as OK. If an error is displayed, try restarting the system, and if an error is still shown, contact **CUSTOMER SERVICE** for support.

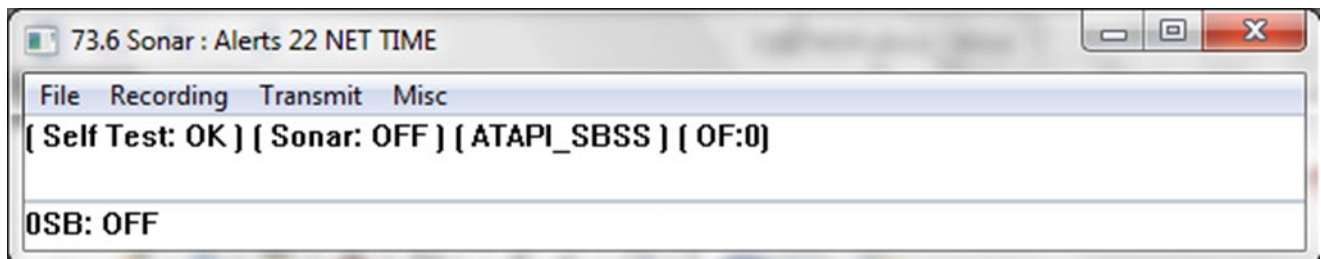
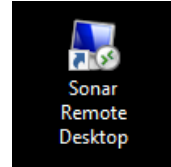

Figure 5-3: Sonar.exe Successful Self-Test

3. Return to the topside computer's display and view Discover to ensure that the NET value in the Status Indicator bar ([FIGURE 5-4](#)) is displaying NET:ON. If it is listed as OFF or an ERROR is displayed, contact **CUSTOMER SERVICE** for support. If both tests are successful, the sonar processor is ready for operations, and subsystems can now be tested.

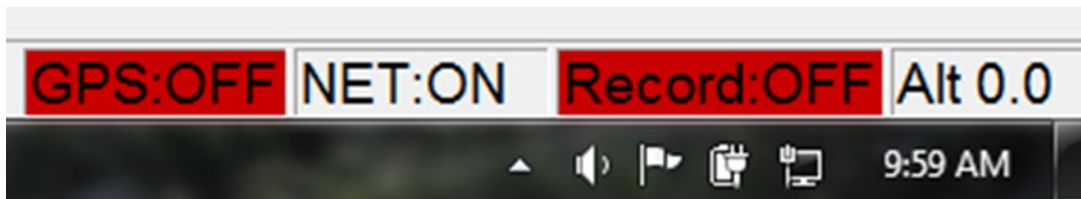

Figure 5-4: Status Indicator Bar- NET:ON

5.2.2 Performing Side-Scan Pre-Deployment Checks

The pre-deployment checks should be performed after the system is activated and before the towfish is deployed. These checks involve verifying that data can be recorded and played back in Discover, rubbing one's hand on the transducer arrays while observing the Sonar display in the Discover Main window; verifying correct heading, pitch, and roll outputs; and zeroing the pressure sensor.

1. Activate your System, using the specific instructions detailed above.

CAUTION! Do not allow the transducer arrays on the Towfish to continuously transmit outside water for an extended period, as damage to the transducer arrays could occur.

2. In Discover, click the Sidescan Control tab in the Lower Control panel, shown in **FIGURE 5-5**.

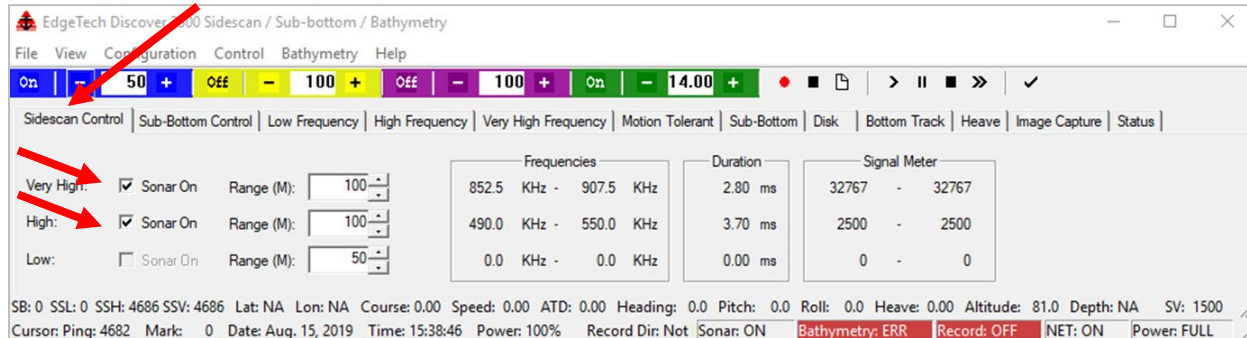

Figure 5-5: Sidescan Control Tab in Discover

3. Turn any two subsystem frequency systems on by selecting the corresponding checkboxes in the Sidescan Tab.
4. Set the ranges for your two selected frequencies to at least 100 meters. Click the N and T buttons on the Shortcut Toolbar in Discover to normalize Gain and TVG.

The transducer arrays on the Towfish should begin transmitting, and data should begin scrolling in the Discover waterfall displays. Data should begin populating the Sidescan control Frequency, Duration, and Signal meter data blocks.

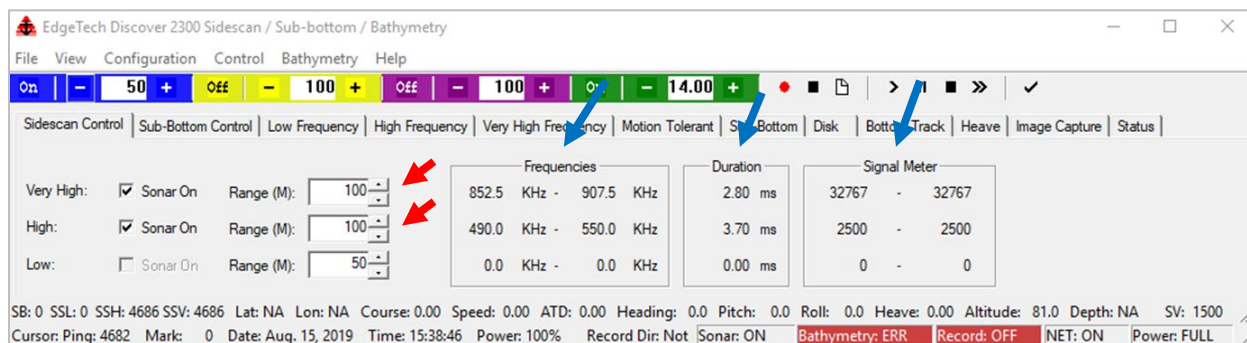

Figure 5-6: Side Scan Control Tab Frequency, Duration, and Signal Meter Datablocks

5. The next step is to test the recording. To do so, select the Disk tab in the Control Panel, populate a file name in the Record File text box, select Browse if you'd like to change the default save directory, and press the red-dotted record button to start recording a file.

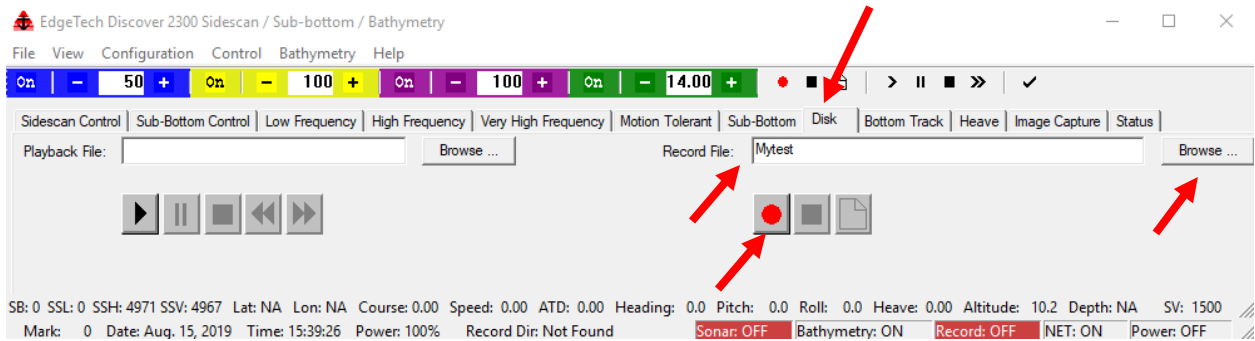

Figure 5-7: Disk Control Tab, Record File Text Box, Browse File Button, and Start Recording Button Locations.

6. Rub the port and starboard transducers briskly one at a time and look for the resulting streaks on the Discover Waterfall Displays.
7. Check compass heading, pitch, and roll data is present. Pitch and roll the towfish and check that the pitch and roll data is correct and changing in the status bar in Discover. The pitch value is displayed as ± 90 with respect to the vertical plane. The Roll value is displayed as ± 180 with respect to the horizontal plane with negative (-) port values and positive (+) starboard values. Rotate the towfish horizontally and check that the heading value is correct and changing correctly in Discover.
8. If a pressure sensor is installed, verify that the pressure display indication is at or nearly zero. The pressure sensor can be zeroed on deck in the Discover, under External Device Controls.

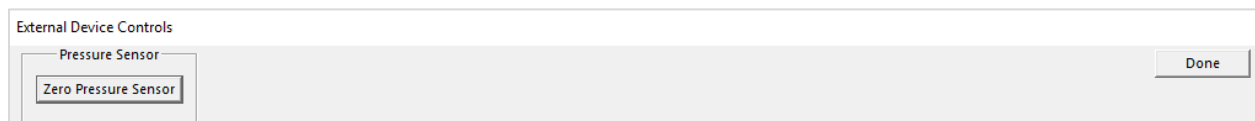

Figure 5-8: External Device Controls- Zero Pressor Sensor Button

9. After the pre-deployment tests are completed, you will stop the recording by pressing the stop button (black square), playback the file by browsing to it using the browse button next to Playback File, and then pressing play. Observe looking for recording issues.

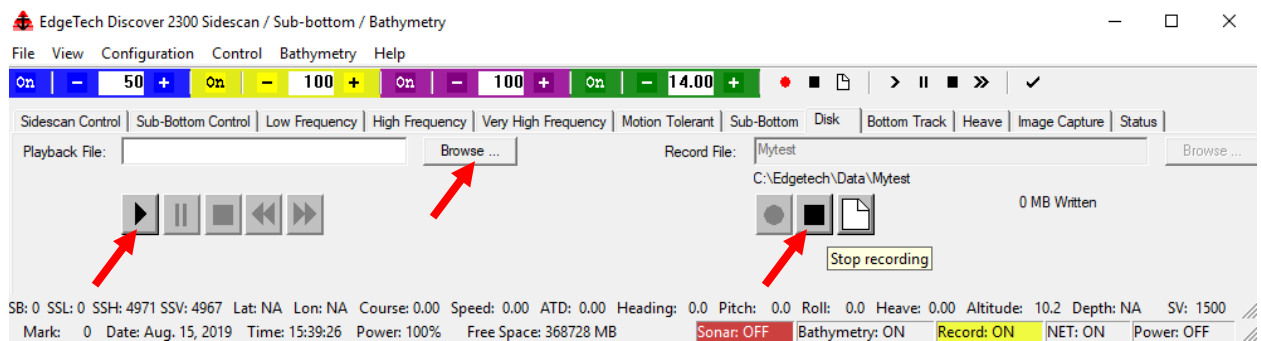

Figure 5-9: Disk Control Tab: Stop Recording Button, Browse for Recording and Play Button

10. Repeat the process for the third sonar subsystem that was not active during the initial test to ensure it is working properly.

5.2.3 Performing Sub Bottom Pre-Deployment Checks

Pre-deployment checks should be performed *before* the Tow Vehicle is deployed and *after* the system is activated. Pre-Deployment checks involve:

- Listening for the transmitted pulses from the Transducers on the Tow Vehicle
- Tapping the fiberglass shell with a hand or, gently, with a screwdriver handle near the PVDF panel while observing the Sub-Bottom Waterfall Display in Discover, ensuring it plays back and navigation is present. The Sub-Bottom Display Window is displayed in [FIGURE 5-10](#) below, and the results of a tap test are displayed in [FIGURE 5-14](#).

NOTE: See the Discover 2300 Software Manual for detailed software information.

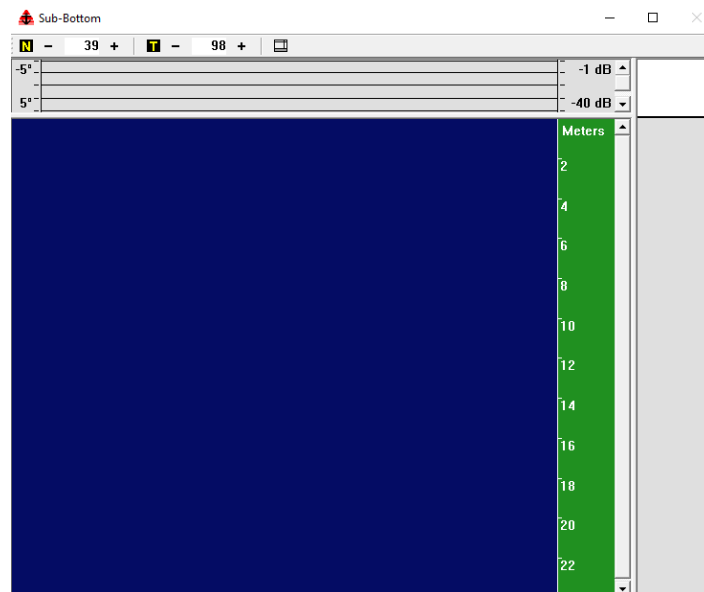

Figure 5-10: Discover 2300 Sub-Bottom Display Window

To perform the pre-deployment checks:

1. Follow the instructions in [ACTIVATING THE TOPSIDE](#) section of this manual and activate the Sub-Bottom amplifiers in Web Relay.
2. Run a Tap Test – Navigate to the Sub-Bottom Control Tab, shown in [FIGURE 5-11](#).

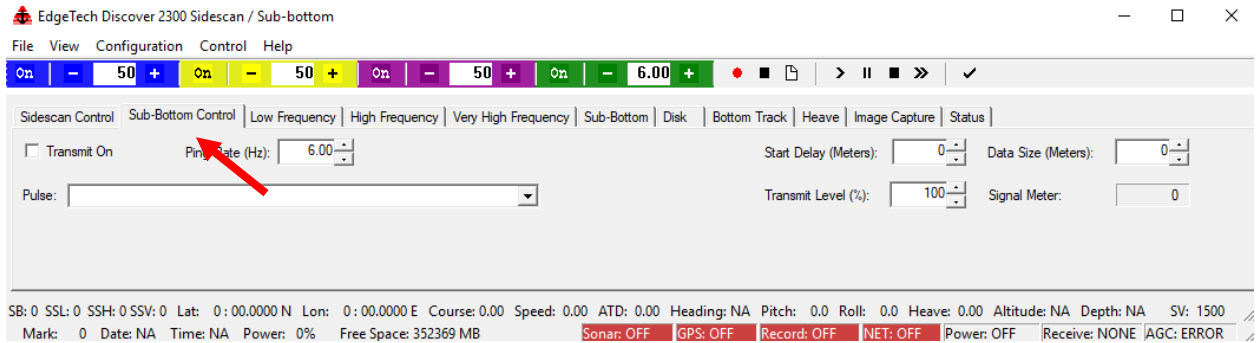

Figure 5-11: The Sub-Bottom Control Tab

- In the Sub-Bottom Control Tab, select a Transmit Pulse using the “Pulse” dropdown. Set “Transmit Level (%)” to “100”. Select the “Transmit On” checkbox. Verify that you can hear the system transmitting. The transducers should begin transmitting (at 100%) and receive data should begin scrolling on the Waterfall Display in Discover Sub-Bottom, from right to left.

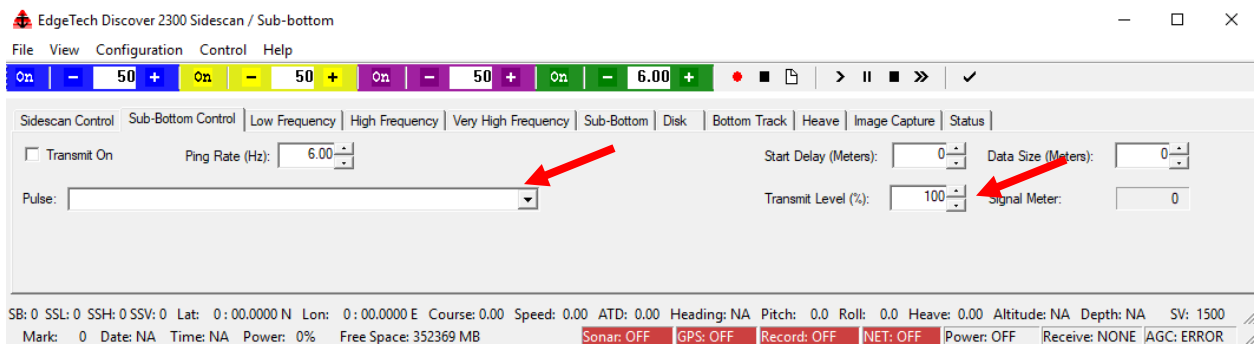

Figure 5-12: Sub-Bottom Control Tab-Pulse and Transmit Level Called Out

- In the Sub-Bottom Control Tab, select a Transmit Pulse using the “Pulse” dropdown. Set “Transmit Level (%)” to “0”. Verify that you can hear the system transmitting. The transducers should begin transmitting (at 0%) and receive data should begin scrolling on the Waterfall Display in Discover Sub-Bottom, from right to left.
- In the Sub-Bottom Display Window Shortcut Toolbar, set Gain to either 0 or -3 dB, and then click Normalize Gain Button.



Figure 5-13: Sub-Bottom Shortcut Toolbar- Range Text Field and Normalize Gain Button Called Out

6. Tap the underside of the tow vehicle near the PVDF receiver with the handle of a screwdriver, while observing the Sub-Bottom Waterfall Display in Discover.

Streaks or noise spikes should be visible in the Waterfall Display, as shown in [FIGURE 5-14](#). This verifies the receive channel is operating.

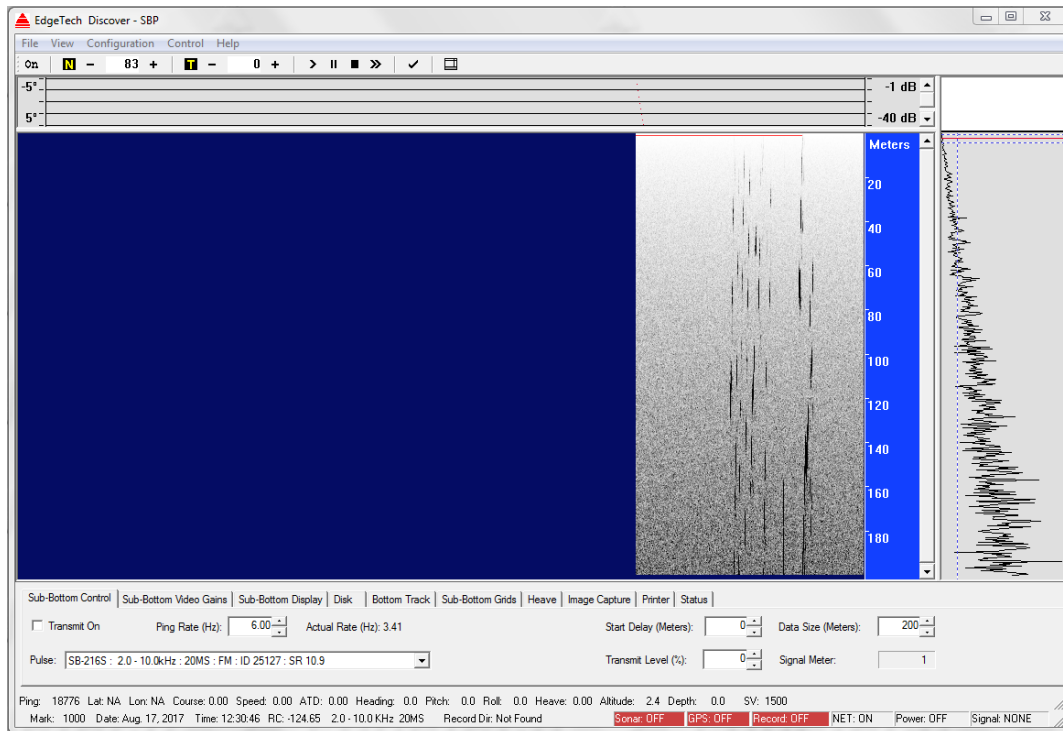

Figure 5-14: Tap Test

5.3 Towfish Deployment

The 2300 is ruggedly built, but care is needed to deploy the 2300 system and get the best survey results. This involves adjusting the bridle to the 90° position, carefully lowering it to an ideal survey depth, utilizing and monitoring the Discover Bottom Tracking feature to avoid striking the bottom, and carefully recovering and disconnecting the towfish when the survey is completed.

CAUTION! The deployment instructions below are only meant as a general guide. Due to varying conditions, exact deployment methods will change, and it is up to the end-user to modify their deployment procedure to match the conditions they are working under.

CAUTION! When lowering the towfish in an area where the bottom topography is unknown, take care not to strike the bottom or a submerged object. Otherwise, damage to the Towfish may occur. Carefully monitor towfish altitude always during the survey. Failure to do so could result in the towfish hitting the bottom or becoming snagged.

CAUTION! Do not tow the towfish too close to the survey vessel. Towing in this manner can cause the Towfish to be pulled in against the hull of the ship due to the low pressure of the propeller wash and the effect of the water flowing by the hull. In addition, sonar reflections from the hull may be evident in the records.

CAUTION! Do not tow the towfish with the nose angled up or down. Doing so can degrade the sonar imagery. Verify that the Towfish is as level as possible when towing it.

NOTE: For detailed towing characteristics for many tow cable types and lengths, along with towfish speeds, with or without a depressor, refer to the **TOWFISH LAYBACK CHARTS** provided in this manual.

NOTE: For detailed information about the Discover software, including how to record data, refer to the “Discover 2300 Software Manual.”

To deploy the Towfish:

1. Ensure the towfish bridle is in the 90° position. Instructions on how to adjust the bridle angle can be found in the **ADJUSTING BRIDLE STRUT POSITION FOR TOWING AND MOVEMENT** section of this manual.
2. With the survey vessel underway at up to two knots, slowly and carefully lower the towfish into the water, well away from the propeller. Do not let the Towfish strike the hull of the survey vessel.
3. Lower the towfish to a depth of about three meters, or just below the propeller wash.
 - a. Set the range for each frequency in the control window shortcut toolbar in Discover.

- b. Normalize gain and TVG by clicking on the shortcut toolbar N and T buttons on both active side-scan display windows in Discover.

4. Click the Bottom Track tab in the Lower Control panel, shown below.

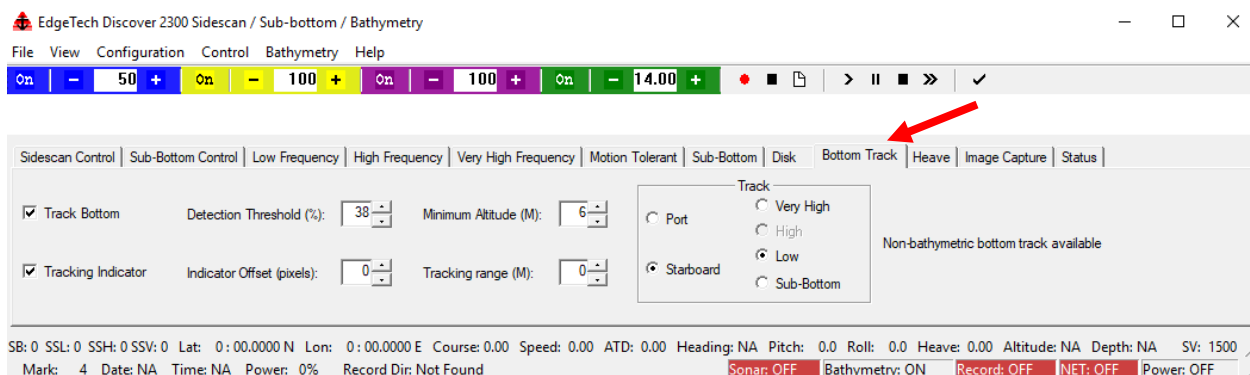

Figure 5-15: Bottom Track Tab

5. In the Bottom Track Tab, make the required settings to track the bottom and note the Towfish altitude in the Altitude display. Lower the Towfish such that its altitude is 10–15% of the range selection. Refer to the Discover 2300 Software Manual for details on the bottom tracking setup.
6. Increase the survey vessel speed to the desired survey speed and adjust the amount of cable out such that the altitude of the Towfish remains at 10–15% of the range selection.
7. If a pressure sensor is installed, verify that the Pressure display indication is working.
8. Secure the tow cable to the survey vessel.
9. Begin recording data.

5.4 Towfish Layback Charts

The following towfish layback charts are provided to assist in towing. Please take the following points into consideration if they are used:

- The standard 2300 towfish currently supports depths no greater than 2000 meters.
- The results listed in these tables are calculated using the Woods Hole WHOI cable program with best-estimated parameters for vehicle weight and buoyancy, as well as cable weight and stiffness. EdgeTech disclaims any liability for consequential damage resulting from using the data in the tables.
- The values contained in these charts are subject to change and have been assigned an error of +/- 10%. Keep this in mind, especially if within 10% of the endpoint of any parameter.
- A combination of too much cable paid out and too slow a tow speed will result in exceeding the maximum vehicle depth. Conversely, too much cable paid out, and too fast a tow speed will result in exceeding the tow cable's max working load. Consult the charts for specific examples.

5.4.1 Cable A302799 Layback Charts:

2300 WITH QTY 4 DW 106 TRANSDUCERS AND 500 METERS OF CABLE A302799 PAID OUT						
Speed (kts)	Speed (m/s)	Cable Paid Out (m)	Max Cable Tension (N)	Depth (m)	Distance Behind Ship (m)	Down Angle from Horiz. (deg)
2.00	1.03	500	5,959	435	230	62
2.50	1.29	500	5,907	384	302	52
3.00	1.54	500	5,937	333	355	43
3.50	1.80	500	6,071	288	393	36
4.00	2.06	500	6,319	251	419	31
4.50	2.31	500	6,683	221	438	27

Table 5-1: 2300 with QTY 4 DW 106 Transducers and 500 Meters of Cable A302799 Paid Out

2300 WITH QTY 4 DW 106 TRANSDUCERS AND 1,000 METERS OF CABLE A302799 PAID OUT						
Speed (kts)	Speed (m/s)	Cable Paid Out (m)	Max Cable Tension (N)	Depth (m)	Distance Behind Ship (m)	Down Angle from Horiz. (deg)
2.00	1.03	1,000	7,376	773	598	52
2.50	1.29	1,000	7,226	651	725	42
3.00	1.54	1,000	7,274	549	806	34
3.50	1.80	1,000	7,520	469	859	29
4.00	2.06	1,000	7,952	407	895	24
4.50	2.31	1,000	8,559	358	919	21

Table 5-2: 2300 with QTY 4 DW 106 Transducers and 1,000 Meters of Cable A302799 Paid Out

2300 WITH QTY 4 DW 106 TRANSDUCERS AND 2,000 METERS OF CABLE A302799 PAID OUT

Speed (kts)	Speed (m/s)	Cable Paid Out (m)	Max Cable Tension (N)	Depth (m)	Distance Behind Ship (m)	Down Angle from Horiz. (deg)
2.00	1.03	2,000	9,946	1,363	1,406	44
2.50	1.29	2,000	9,683	1,121	1,608	35
3.00	1.54	2,000	9,838	939	1,727	29
3.50	1.80	2,000	10,352	804	1,802	24
4.00	2.06	2,000	11,176	700	1,851	21
4.50	2.31	2,000	12,283	620	1,885	18

Table 5-3: 2300 with QTY 4 DW 106 Transducers and 2,000 Meters of Cable A302799 Paid Out

2300 WITH QTY 4 DW 106 TRANSDUCERS AND 3,000 METERS OF CABLE A302799 PAID OUT

Speed (kts)	Speed (m/s)	Cable Paid Out (m)	Max Cable Tension (N)	Depth (m)	Distance Behind Ship (m)	Down Angle from Horiz. (deg)
2.00	1.03	3,000	12,421	1,920	2,237	41
2.50	1.29	3,000	12,093	1,574	2,500	32
3.00	1.54	3,000	12,380	1,322	2,652	26
3.50	1.80	3,000	13,172	1,134	2,747	22
4.00	2.06	3,000	14,395	992	2,809	19
4.50	2.31	3,000	16,004	880	2,851	17

Table 5-4: 2300 with QTY 4 DW 106 Transducers and 3,000 Meters of Cable A302799 Paid Out

2300 WITH QTY 4 DW 106 TRANSDUCERS AND 4,000 METERS OF CABLE A302799 PAID OUT

Speed (kts)	Speed (m/s)	Cable Paid Out (m)	Max Cable Tension (N)	Depth (m)	Distance Behind Ship (m)	Down Angle from Horiz. (deg)
2.00	1.03	4,000		2,000 Meter Max Depth Exceeded		
2.50	1.29	4,000		2,000 Meter Max Depth Exceeded		
3.00	1.54	4,000	14,921	1,704	3,578	25
3.50	1.80	4,000	15,992	1,465	3,692	22
4.00	2.06	4,000	17,614	1,283	3,767	19
4.50	2.31	4,000	17.8 kN Maximum Working Load Exceeded			

Table 5-5: 2300 with QTY 4 DW 106 Transducers and 4,000 Meters of Cable A302799 Paid Out

2300 WITH QTY 4 DW 106 TRANSDUCERS AND 4,500 METERS OF CABLE A302799 PAID OUT

Speed (kts)	Speed (m/s)	Cable Paid Out (m)	Max Cable Tension (N)	Depth (m)	Distance Behind Ship (m)	Down Angle from Horiz. (deg)
2.00	1.03	4,500		2,000 Meter Max Depth Exceeded		
2.50	1.29	4,500		2,000 Meter Max Depth Exceeded		
3.00	1.54	4,500	16,190	1,894	4,040	25
3.50	1.80	4,500	17,402	1,630	4,164	21
4.00	2.06	4,500	17.8 kN Maximum Working Load Exceeded			
4.50	2.31	4,500	17.8 kN Maximum Working Load Exceeded			

Table 5-6: 2300 with QTY 4 DW 106 Transducers and 4,500 Meters of Cable A302799 Paid Out

5.5 Towfish Recovery

CAUTION! The following procedure is only meant as a general guide. Due to varying conditions, exact recovery methods will change, and you must modify your procedure to match the conditions you are working under.



Figure 5-16: 2300 Being Recovered

To recover the Towfish:

1. Slowly retrieve the tow cable until the towfish is just below the surface.
2. Click the Towfish Control tab and deselect the High Sonar On and Low Sonar On checkboxes.
3. Slow the survey vessel speed to under two knots.

NOTE: If practical, put the survey vessel in neutral while the Towfish is brought on board.

4. Recover the towfish from the water and carefully lower it on deck.
5. Turn off the Topside Processor.
6. Disconnect the tow cable from the 6-pin male tow cable connector on the Towfish extension tow cable. Inspect all connectors; clean and lubricate, as necessary.
7. Install the dummy plug on the extension cable on the towfish.
8. If the 2300 Towfish is to be moved by winch or crane across the deck or to a dock, adjust the bridle angle to a safer angle. Refer to the **ADJUSTING BRIDLE STRUT POSITION FOR TOWING AND MOVEMENT** section of this manual for instructions.
9. Refer to the **CLEANING AND INSPECTING THE TOWFISH AFTER USE** section of this manual for instructions on how to clean and inspect the Towfish, the tow cable, and the underwater connectors after use.

6.0 MAINTENANCE

6.1 Cleaning and Inspecting the Towfish After Use

Cleaning the towfish after use maintains its form and function. EdgeTech suggests hosing down the towfish with fresh water after each use. The focus should be making sure the transducers are cleared of debris and buildup is removed. Periodically cleaning the transducers with non-abrasive detergent and thoroughly rinsing with fresh water is suggested.

Inspect all internal and external cables, connectors for damage or loose connections. If there is significant damage, contact **CUSTOMER SERVICE** for support.

The connector endcap should be inspected regularly for damage and that the active aluminum anodes are not corroded. If there is significant damage or corrosion, contact **CUSTOMER SERVICE** for support.

All connectors should be checked for corrosion or oxidation. Male pin oxidation can be removed from the pins by rubbing the contacts lightly with 800 grit emery cloth cut into strips equal to or less than the width of a contact. A pencil eraser can also be used for this purpose. Female sockets can be cleaned using a cotton swab and rubbing alcohol. A .22 caliber bore brush with only nylon bristles can be used to remove light oxidation.

The life and reliability of the connectors can be extended by applying a thin film of silicone dielectric grease to the entire surface of each male pin. A small amount of grease should also be applied to the opening of each female socket.

6.2 Tail Fin Removal and Installation

The two towfish tail fins can be removed for easier transport and adjusted if required.

6.2.1 Tail fin Removal

Removing the tail fins involves unthreading the [3] hex-head bolts, [3] washers, and [3] hex nuts from the fin mounts on the port and starboard side of the towfish.



Figure 6-1: View of Inner-Fin Bolt Mounting (Hex Nuts, Washers)

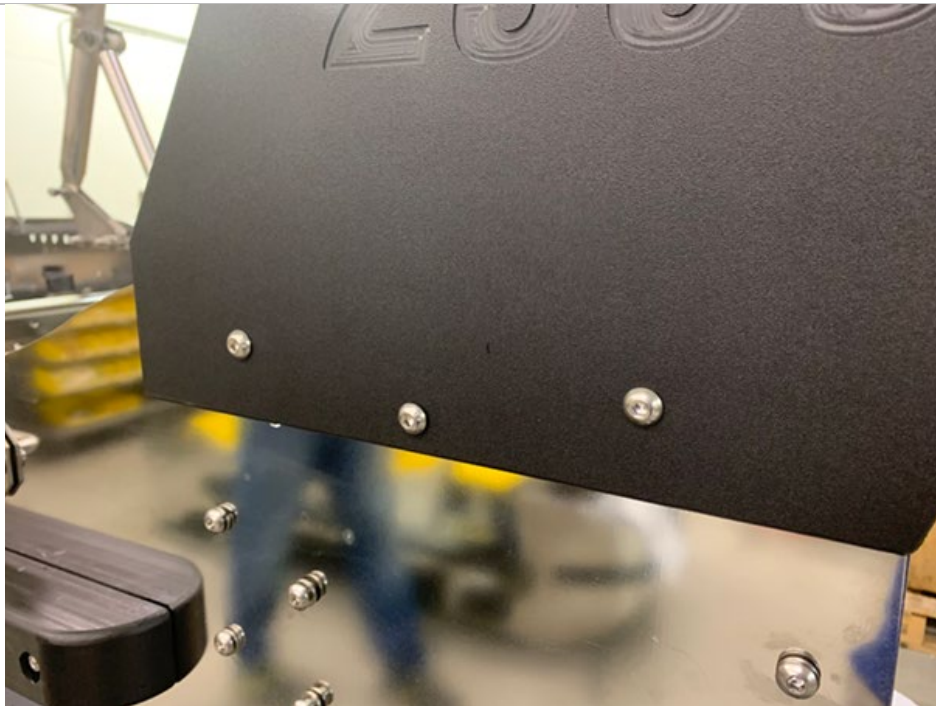

Figure 6-2: Outer-Fin Bolt Mounting (Hex-head Bolts)

Tools Required:

- Socket Wrench with 1/2" socket or 1/2" sized crescent wrench or adjustable crescent wrench
- Hex screwdriver or Allen wrench

Instructions:

1. Use the hex head screwdriver to hold the hex-head bolt in place and the 1/2" socket wrench to unthread and remove the hex nut.



Figure 6-3: Unthreading Tail Wing Assembly with Hex Screwdriver and Wrench.

2. Pull the hex bolt and washer from the mounting.
3. Repeat the unthreading bolt assembly procedure on the second tail fin.

6.2.2 Tail Fin Installation

Installing each tail fin involves aligning the tail fin, model number out, to the bolt holes on the tail fin mount, and threading the [3] hex bolt hardware in securing it to the towfish.

Tools Required:

- Socket Wrench with 1/2" socket or 1/2" sized crescent wrench or adjustable crescent wrench
- 3/16" hex head screwdriver or Allen wrench

Instructions:

1. Align tail fin model number out to the bolt holes on the tail fin mount.



Figure 6-4: Tail Fin Alignment (Tail Fin and Model Number out)

2. Install hex head bolt hardware. Using a hex screwdriver and 1/2" wrench, thread [3] hex head bolts through from outside fin, [3] thread washer, and [3] hex nut from within.

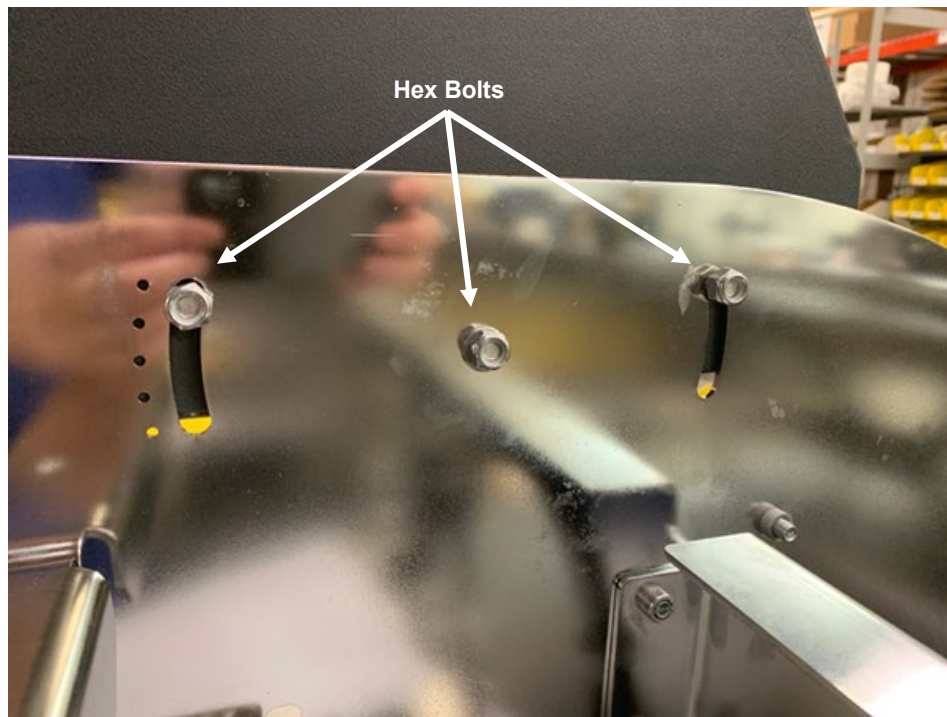

Figure 6-5: Inner Tail Bolt Positions (future versions will be fixed and not adjustable)

3. Repeat bolt assembly procedure on the other side of the towfish.

6.3 Opening the Towfish

Opening the Towfish Bottle requires unthreading at least 13 of 17 mounting hex screws to release the top panel from the towfish. Removing all 17 hex screws and the top panel completely gives access to all internal electronic components. Removing the 13 screws starting from the back allows the top cover to be angled back exposing all but components forward (usually sub-bottom transducers)

Tools Required

- 3/16" hex head screwdriver or 3/16" Allen wrench

Instructions:

1. Using the 3/16" hex screwdriver, remove the [17] hex screws from the top of the towfish. If removing 13 hex screws is desired, do not unthread the forward four screws that go through the black mounting strip.

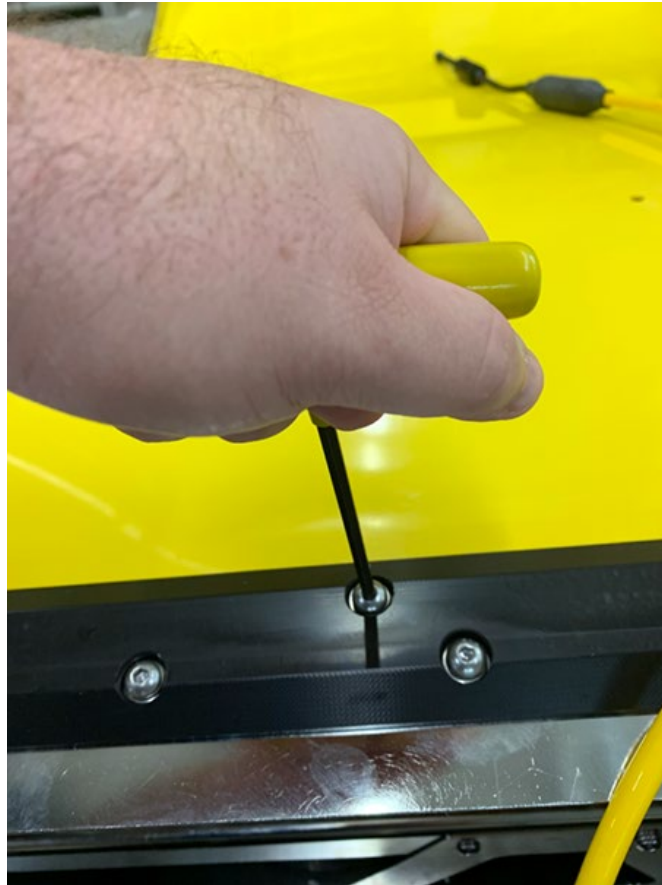

Figure 6-6: Top Cover Hex Screw Removal

2. Carefully remove the top cover. If all bolts are removed, the top cover can be slid aft out of the towfish. If only 13 hex screws are removed, the cover is flexible and can be carefully bent or slid from beneath any obstructing bolt assemblies. Avoid extreme bend angles.

6.4 Electronics Bottle Installation and Removal

The electronic bottles can be easily removed from the towfish for service and repair. Detailed instructions for removing and installing both vertically and horizontally aligned bottles are provided below.

- Specific instructions on wiring can be found in the System Technical and User's Guide provided with each component. Endcap diagrams are found in the **MULTIPLEXER AND SONAR PROCESSOR ENDCAP DIAGRAMS** section of this manual.
- Please contact EdgeTech **CUSTOMER SERVICE** for information, service, and support for any EdgeTech provided electronics component. This ensures good service and that specific warranties are preserved.

6.4.1 Removing Vertically Mounted Sub-Bottom Transducer

The sub-bottom transducers can be removed by removing the top cover of towfish, unplugging the cable from the bottle, removing the worm-clamp that secures the bottle to the mounting brackets, loosen and turn the mounting brackets if necessary and lift the bottle from the towfish.

Tools Required:

- 3/16" hex head screwdriver or 3/16" Allen wrench
- Flathead screwdriver

Instructions:

1. Unplug the cable from the sub-bottom transducer or unplug the cable from the endcap.
2. Remove towfish top cover by unthreading the 17 hex head screws securing it to the towfish. See the [OPENING THE TOWFISH](#) section of this manual for detailed instructions.
3. Using the flathead screwdriver, unthread the worm clamp screw releasing the worm clamp from the vertically installed transducer and [4] transducer mounting brackets. Remove loose worm clamp.

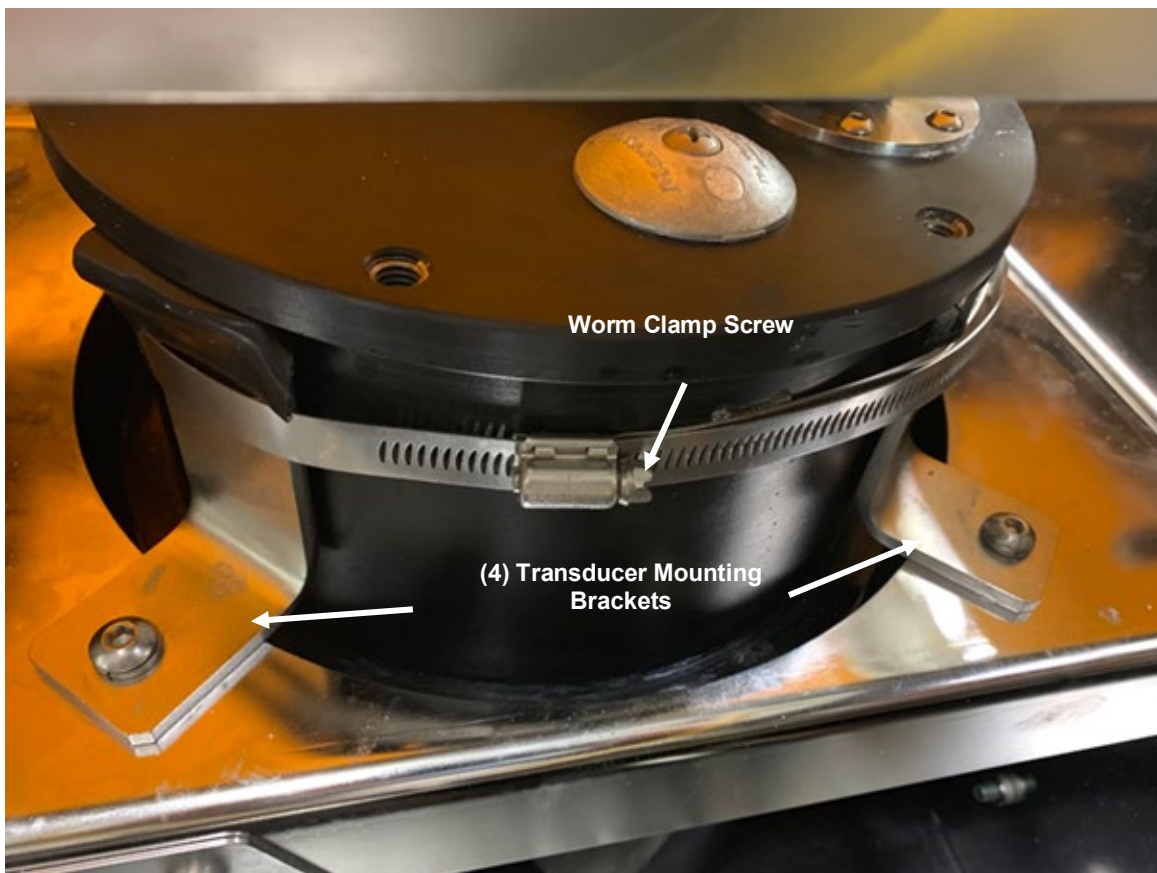

Figure 6-7: Mounted Sub-Bottom Transducer secured by Mounting Brackets and Worm Clamp

4. If required, loosen the [4] transducer mounting brackets with the 3/16" hex head screwdriver and turn brackets away from the bottle.
5. Lift the bottle carefully from the towfish.
6. Replace the towfish top cover and rethread [13 or 17] hex screws using the hex screwdriver.

6.4.2 Installing Sub-Bottom Transducers

The sub-bottom transducers are installed by removing the top cover of towfish, aligning the mounting brackets to accept a vertically mounted transducer, gently setting the transducer into the brackets, securing the brackets and transducer with a tightened worm-clamp and plugging the cable back into the transducer.

Tools Required:

- 6/16" Hex head screwdriver or 3/16" Allen wrench
- Flathead screwdriver

Instructions:

1. Remove towfish top cover by unthreading the 17 hex head screws securing it to the towfish. See the [OPENING THE TOWFISH](#) section of this manual for detailed instructions.
2. Ensure that the [4] mounting brackets are aligned to accept a transducer. If adjustment is required, loosen hex screws with a 3/16" hex screwdriver and turn mount until aligned correctly.



Figure 6-8: Vertical Mounting Brackets Proper Alignment

3. Gently set the transducer housing into the brackets. The fit should be firm; the sub-bottom transducer should be relatively level, and cabling should be managed so as not to obstruct the functionality of the attached bottle or positioning or functionality of the others.
4. Install the worm clamp around all four mounts, transducer, and clamp. Ensure no cabling is snagged or clamped. Tighten worm clamp using the flathead screwdriver.

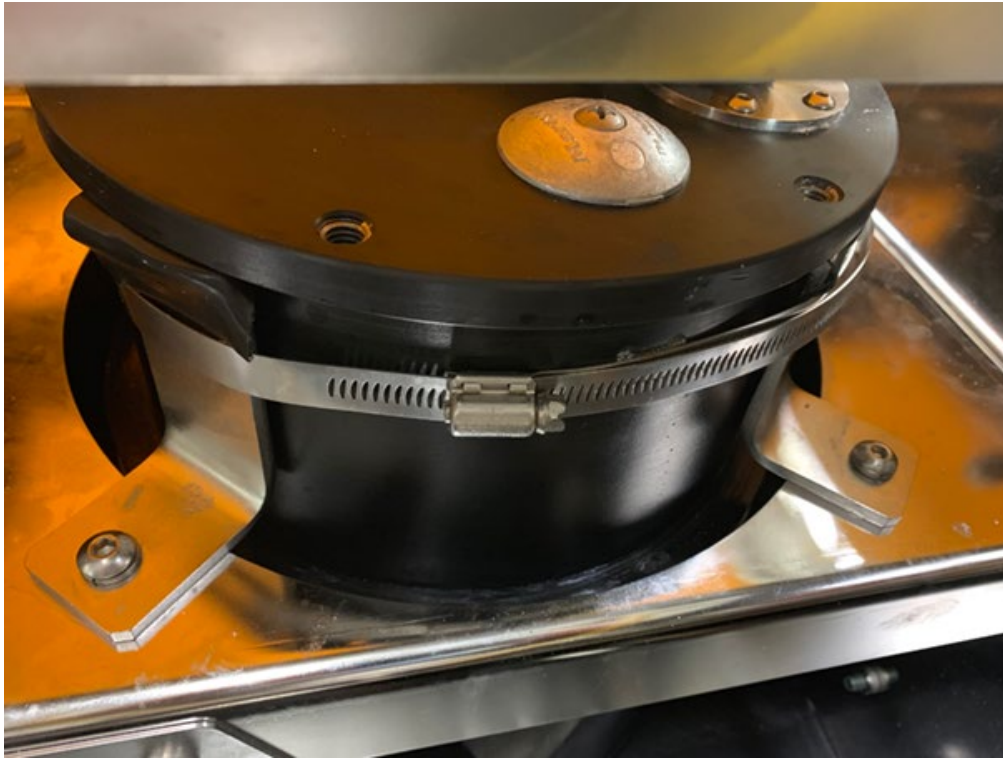

Figure 6-9: Worm Clamp Secured Around Mounting Brackets and Transducer

5. Plug the 3-pin Transmit cable into the sub-bottom transducer endcap and, if needed, connect the other side one of four sub-bottom TX connectors on the Sonar Bottle Endcap.



Figure 6-10: Correctly Installed Sub-Bottom Transducer

6. Replace the towfish top cover and rethread [13 or 17] hex screws using hex 3/16" hex head screwdriver.

6.4.3 Removing Horizontally Mounted Electronic Bottles

The horizontal electronic bottles (sonar processor and multiplexer) can be removed by opening the top cover of the towfish, disconnecting the cabling, removing the aft mounting ring by unthreading the five hex bolt assemblies securing it, and sliding the electronics bottle out of the fixed mounting rings toward the aft end of the towfish.

Tools Required:

- Socket Wrench with 1/2" socket or 1/2" sized crescent wrench or adjustable crescent wrench
- 3/8" Hex screwdriver or Allen wrench

Instructions:

1. Remove towfish top cover by unthreading the 17 hex head screws securing it to the towfish. See the **OPENING THE TOWFISH** section of this manual for detailed instructions.
2. Note the installed roll position of the horizontally installed electronics endcap and any cabling configurations necessary for re-installation.
3. Unplug all cabling from the horizontally installed electronic bottle end cap connectors or the endcap connectors of the attached electronic bottles. Install dummy plugs into connectors where needed.
4. Remove the aft Mounting Ring by unthreading the [5] hex bolts, [5]lock washers, [5]washers, and [5] hex bolts from the fixed towfish mounting ring.

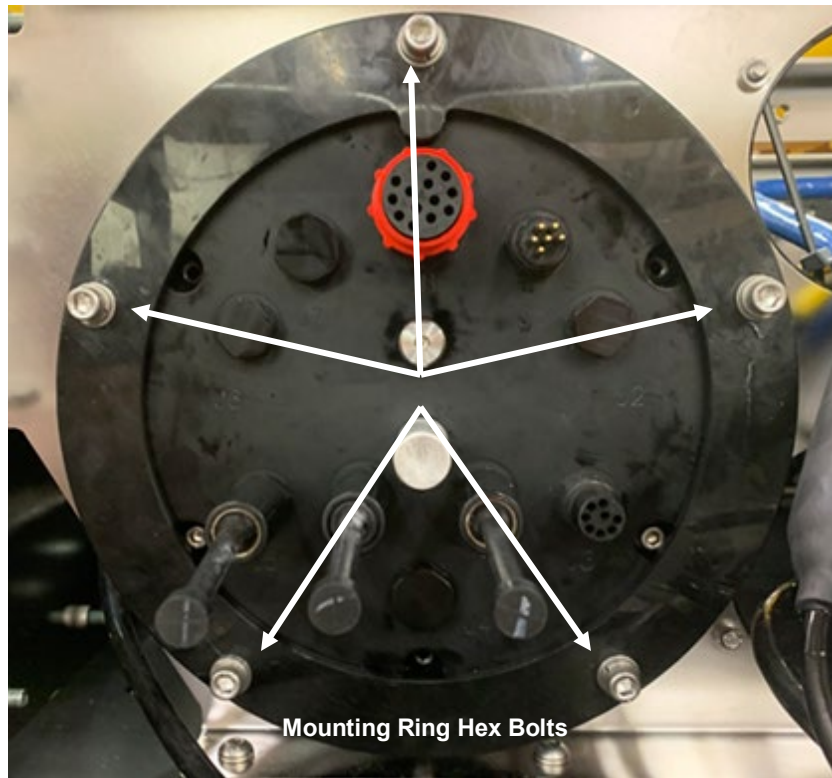

Figure 6-11: Aft Horizontally Installed Electronics Bottle



Figure 6-12: Detached Mounting Ring

5. Carefully slide the electronics bottle from both the fixed mounting rings in the towfish from the aft end of the towfish.
6. Replace the towfish top cover rethread [13 or 17] hex screws using a hex screwdriver.

6.4.4 Installing Horizontally Mounted Electronic Bottles

Horizontally mounted electronic bottles are installed by removing the top cover of the towfish, sliding the electronics bottle into the fixed mounting rings, aligning the bottles roll orientation, reinstalling the detached mounting ring to the aft fixed mounting ring, and reattaching the cabling.

Tools Required:

- Socket Wrench with 1/2" socket or 1/2" sized crescent wrench or adjustable crescent wrench
- 3/8" Hex screwdriver or Allen wrench

Instructions:

1. Remove towfish top cover by unthreading the 17 hex head screws securing it to the towfish. See the [OPENING THE TOWFISH](#) section of this manual for detailed instructions.
2. Review your notes on the proper roll orientation of horizontally installed electronics bottles and cabling.
3. Gently slide the electronic bottle horizontally through the two fixed mounting rings from the aft side of the vehicle until the lip of the endcap is against the aft mounting ring. Adjust the electronic bottle roll to the proper orientation.
4. Reinstall Mounting Ring by properly aligning the detached mounting ring with the fixed mounting ring and threading the [5] hex bolts, [5] lock washers, [5] washers, and [5] hex bolts to the aft fixed mounted ring.

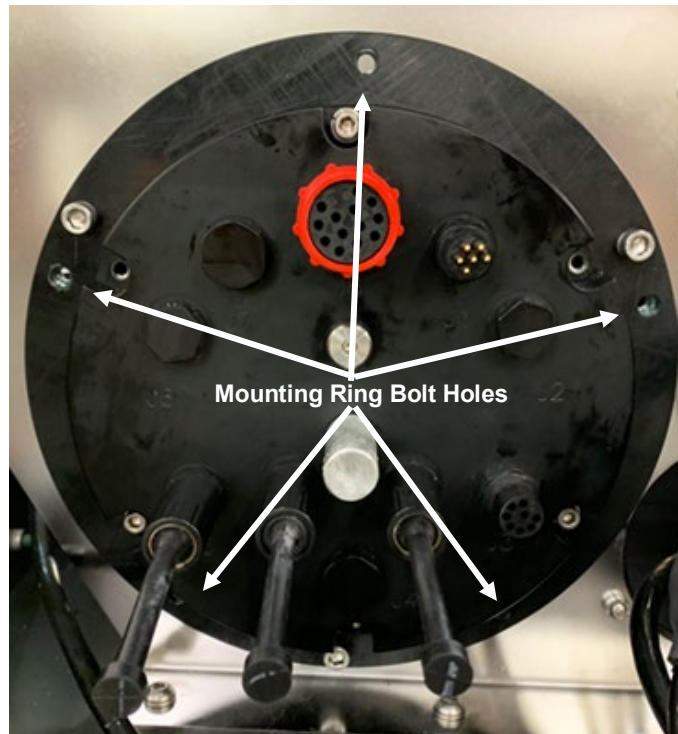

Figure 6-13: Aft Mounting Ring Bolt Hole Locations

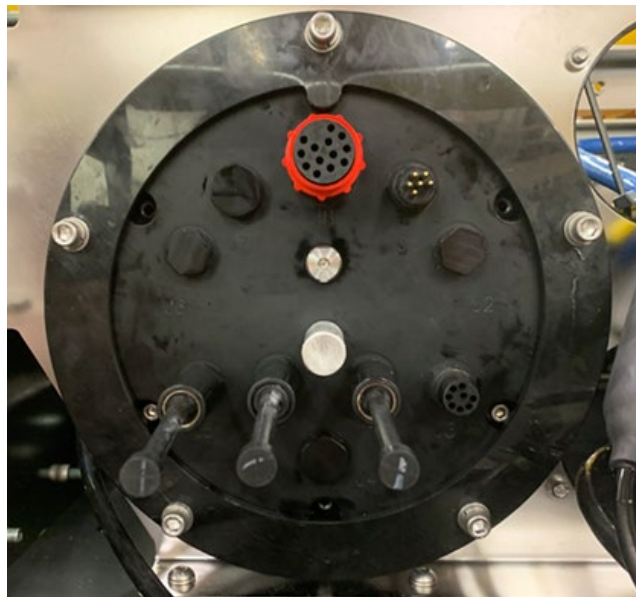

Figure 6-14: Mounted Aft Mounting Ring

5. Reconnect cabling to end cap connectors. Documentation on this can be found in the *Technical and User's Guide* of the electronic bottle installed. Cabling should be managed so as not to obstruct the functionality of the attached bottle or positioning and functionality of others.
6. Replace the towfish top cover and rethread [13 or 17] hex screws using hex screwdriver

6.5 Towfish Weight Adjustment

NOTE: The 2300 towfish comes weighted to meet quality assurance stability requirements, and most use cases would not change stability parameters enough to require a weight change. If an edge case is experienced, please consult **CUSTOMER SERVICE** before any modifications.

Adjusting the vehicle's front weight is accomplished by adding or removing EdgeTech weights from the forward weight assembly weight stacks.



Figure 6-15: Forward Weight Assembly

Required Tools:

- Socket Wrench with 3/4" socket

Instructions:

1. Unthread the hex nut from the bolt securing the weight stack using the socket wrench.

2. Remove or install EdgeTech weight. Keep alignment consistent with other weights.
3. Rethread hex nut back on to thread completely.
4. Repeat on other bolts as needed. Ensure equal weight distribution unless otherwise called for.

7.0 TROUBLESHOOTING

7.1 Towfish Troubleshooting Guide

The 2300 Towfish is a complex computer-controlled system that requires engineering expertise and the proper test equipment to service. For any service or troubleshooting, please contact **CUSTOMER SERVICE** for updated instructions, drawings, documentation, tools, and guidance. This ensures success and is necessary to maintain the product's warranty.

The 2300 Towfish is a software-controlled computer system that includes both digital and analog connections between components. Many of the digital connections share and are dependent on the same data and address lines, so the failure of one component may cause others to fail. Therefore, to successfully troubleshoot an issue, it is best to understand the dataflow and methodically test to isolate the problem.

An example methodical test procedure is as follows:

1. Ensure that the system is properly installed with all cables connections mated with connectors.
2. Check that fuses have not blown and that the lines connecting them are to the specified electrical limits. Fuses may fail if a wrong connection has been made during setup. For a fuse to fail, there existed a momentary condition that caused the power system to exceed its limits. Such failures can be traced to connecting/disconnecting active connections or selecting the incorrect signal for acoustic transmission. These are often one time events where replacing the fuse can be safely done without risk to the system or the user. Always replace fuses with those of the same value. If a fuse fails again within a short time, there are more serious problems within the corresponding unit, and **CUSTOMER SERVICE** should be contacted.
3. Disconnect the cable from the Towfish and verify that the voltage at the end of the Test or Tow cable is nominally 375vdc. If the voltage is not present or significantly less, there is an issue with the Starmux IV or the cable.
4. Reconnect the cable and verify that the 2300 hardware is drawing current from the Starmux IV. The nominal current is approximately 230mA amps. If the number is much smaller or well above this value, for an extended period of 10-20 secs, turn off the Starmux IV and contact **CUSTOMER SERVICE**. There are no user-serviceable parts within the Starmux IV or either of the 2300 pressure housings.
5. Confirm that the proper equipment is being utilized. While the Starmux IV can be used to operate other EdgeTech tow bodies, the same is not true for other Starmux versions to operate the 2300. Only a Starmux IV can be used to operate a 2300.
6. Confirm that all devices are configured to be operating at the same serial data rate as the Multiplexer's Telemetry configuration. The default is 9600/N/8/1.
7. Ensure that any optional internal or external components aren't causing the problem by disconnecting them from the system.

If the above checks do not identify or remedy the problem, attempt to isolate the failure to one of the major system components: the sonar processor, the modem/power unit, the towfish, or the tow cable.

The following sections provide some specific areas to check and easily identifiable clues to look for in making an educated guess as to the source of the problem. This is only down to the module or PCB level.

7.1.1 Towfish

Before troubleshooting the Towfish, verify that the command and data links between the towfish and topside are working.

NOTE: It is recommended that all attempts be made to see if a problem is external to the Towfish before opening it. Also, contact EdgeTech to receive prior approval to open the towfish chassis so as not to risk voiding the warranty.

WARNING! High voltage (375 VDC) is always present in the electronics assembly when powered.

7.1.1.1 No Sonar Data

If the sonar display does not scroll, check to be sure that the transducers are pinging. If the transducers are pinging, and the data link is working, the problem is most likely related to the topside processor and/or data modem.

If the display scrolls but is blank, and the transducers are firing, or data is absent in all or individual channels, contact **CUSTOMER SERVICE** for support. The issue is most likely withing the Starmux IV or Electronics bottle of the vehicle.

7.1.1.2 Reported Errors

REPORTED ERROR	INDICATION
"No Sonar Device Found"	indicates the CPU does not connect to the sonar processor card
"IF_DIAG"	Indicates the Sonar Processor has detected an error and will not run. Cycle power on Towfish recheck error.
HM_Sensors"	Indicates the system failed one or more of the Heath Monitor checks on startup. If this error is found, check the POST section under the sonar status window in sonar.exe.

Table 7-1: Reported Errors

7.2 Starmux IV Troubleshooting

SYMPTOM	PROBABLE CAUSE	CORRECTIVE ACTION
The green POWER indicator does not illuminate when the unit is turned on.	The POWER switch in the front or rear of the unit is not turned on.	Verify that both POWER switches are on.
	No AC power.	Verify that the Starmux IV is connected to AC power. Check the AC power source. Verify that the fuse is good.
	5 amp fuses on rear panel VAC connection are bad.	Check fuses for continuity. Replace if necessary.
	The indicator is not operating.	Open the unit and check the indicator LED and wiring.
	The 375 VDC 2.5A fuse mounted to the rear panel is bad	Check the fuse for continuity. Replace if necessary.
The green LAN indicator does not illuminate when the unit is turned on.	There is no connection between the digital link and the external topside processor.	Check the LAN connections between the STARMUX IV unit and the topside processor.
	The indicator is not operating.	Open the unit and check the indicator LED and wiring.
	Tow cable between the digital link and the tow vehicle is disconnected or faulty.	Check connections and tow cable.
The green LINK indicator on the Starmux IV continues to flash after several minutes, and no LINK is established.	Modem settings on the digital link are incorrect.	Contact CUSTOMER SERVICE
	Tow fish is faulty.	Check the unit using a different tow fish.
	LAN cable disconnected.	Check the LAN cable connection.
The DISCOVER survey software (if used on external topside) reports, "Cannot ping towfish."	Tow cable disconnected.	Check the tow cable connection.
	Modem settings are incorrect.	Please contact CUSTOMER SERVICE for modem settings.

SYMPTOM	PROBABLE CAUSE	CORRECTIVE ACTION
	The modem disconnected internally on the digital link.	Check all connections to the modem are correct per the wiring diagram.
	Improper settings in DISCOVER (if used on external topside).	Check that under the "Configuration" pull-down "Network," the displayed address is 192.9.0.101 with "Port" set to 1700.
	The tow vehicle is faulty.	Verify the tow vehicle using a different digital link. Verify the digital link with a different tow vehicle.

Table 7-2: Starmux IV Troubleshooting Table

7.3 Computer System Restoration

The following section outlines the procedures for backing up and restoring the system drive.

CAUTION! All data will be lost upon restoring the system to factory settings. Be sure to backup all data before performing the procedure below.

5. Ensure that the topside is off.
6. Insert USB3 flash drive in a blue USB3 port.
7. Start topside and be prepared to press F** key when prompted:
 - a. If the topside is rack mount, press F11.
 - b. If the topside is a laptop, press F12.
8. Under Please select boot device: By using up/down arrow keys, select EUFI: Corsair Voyager 3.0 000A, then press Enter.
9. Wait for Paragon Backup & Recovery 14 Home screen to appear, then click the Restore icon.
10. On Welcome to the Restore Wizard screen, click Next.

11. Browse for Archive and click a specific image (the file ending with the extension “.pbf”). When the Archive File Details window appears, click Next.
12. At What to restore window, click Basic MBR Hard Disk 0, click Next.
13. At Where to restore window, ensure that Basic MBR Hard Disk 0 is already selected (brown box around it). If it is not, use the up/down arrow keys to select. Click Next.
14. At the Restore results window, make no selection and click Next.
15. At the Ready to restore from the archive window, select Yes, apply the changes physically. Click Next. *Restoring will begin.*
16. At completing the restore wizard, click Finish. Click Shutdown.
17. Remove the USB3 flash drive and restart the topside.
18. Re-boot and click on the Windows icon and navigate to Control Panel > System. Activate Windows using the supplied key code on the rear of the laptop.

8.0 KITS:

8.1 AUV/ROV Mounting Kit

Instructions:

The 2300 sonar processing bottle can be separated from the 2300 power/telemetry multiplexer and used independently with the Side Scan or Sub-Bottom transducers on a customer's AUV/ROV. The user can directly connect to the bottle's J1 bulkhead to provide power to the system electronics (Housekeeping), sub-bottom power amplifiers, as well as connect to the system's 10/100 Ethernet and 2x Triggers (Table 8-1).

CONNECTOR J1 (DBH13M)	DEFAULT WIRING
1	+Vdc for 2205 Elex
2	N/C
3	0Vdc for 2205 Elex
4	Ethernet (Brown) - Trigger 0/A
5	Ethernet (White/Brown) - Trigger 0/A; GND
6	Ethernet (Blue) - Trigger 2/C
7	Ethernet (White/Blue) - Trigger 2/C; GND
8	Ethernet (Orange)
9	Ethernet (White/Orange)
10	Ethernet (Green)
11	Ethernet (White/Green)
12	+Vdc for SB Amps
13	0Vdc for SB Amps

Table 8-1: Main I/O (J1) Connector Configuration

To power the sonar bottle's Housekeeping and Sub-Bottom amplifiers, power must be applied to pins 1, 12 (+48vdc), and 3, 13 (Power Return). If the Sub-Bottom amplifiers are NOT being used, then it is only necessary to apply +48vdc to pin 1 and Power Return (pin 3). At 48vdc, the system will draw

nominally 125 watts if ALL four 106 power amplifiers are driving four 106 transducers. The sonar bottle provides 44,000uF of capacitive reserves for this configuration, but this may be insufficient to maintain the power amplifier's output level relative to the user's power supply's ability to support the momentary transmission surge and re-charge. It may be necessary for the user to place additional external capacitive banks to support this configuration. EdgeTech suggests that when independently operating the sonar bottle, no more than two Sub-Bottom transducers be used as the additional signal gain from four transducers would not provide a benefit unless the user was operating at a significant distance from the ocean floor. When using only two 106 transducers, the power draw will be nominally 80 watts.

As noted above, the use of external capacitive banks (20,000 to 40,000uF) may be required to support the power requirements during acoustic transmissions. While a power supply may be rated well in excess of the system's requirements, it must maintain that power during a quick "rate of change" associated with an acoustic transmission. The re-charge current has been shown to peak at 3.5 amps, but the ability to reach this peak is a function of the external power supply used for the Sub-Bottom amplifiers. Many power supplies will momentarily "droop" during the acoustic transmission, which in turn produces a lower output power or to adversely affect other systems that share those power lines. To compensate for this, a capacitive bank can provide the necessary instantaneous power to offset this droop. The capacitive bank's size must be balanced between its ability to offset the droop and to re-charge before the next ping. This is typically found through experimentation using the actual vehicle supply.

In the suggested configuration, the user will remove two 106 transducers and the sonar bottle from the 2300. The Optional SS/SB Array Mounting Kit (sold separately) provides the necessary hardware to mount the transducers to the user's platform (Table 8-2). Dummy plugs (provided with the 2300) must be inserted into ANY unused bulkhead on the sonar bottle. This is especially true for the unused Sub-Bottom connectors, as all power amplifiers will be active during any acoustic transmissions. Power/Ethernet/Trigger are connected to the sonar bottle per drawing 0022208. The mating pigtail is a MCIL13F MacArtney/Subconn Power/Ethernet Series assembly. Onboard the 2300 is a PVDF panel that can be removed from the vehicle, or the user can utilize legacy line arrays as a receiver. Either can be plugged into the sonar bottle. Several factors influence the positioning of the Sub-bottom profiler to transmit and receive elements on an ROV, not least of which is noise sources on the vehicle. Ideally, the 106 transducers should be placed nominally 20" (50.8cm) in front of the PVDF panel's leading edge and along the centerline that bisects the receiver in the along-track direction.

The 2300 Multiplexer (MUX) cannot operate independently of the Starmux topside. The MUX requires a 375vdc voltage that has been combined with a telemetry signal for proper operation.

Kit Part List

0022261		ASSY TOP KIT 2300 SS / SB ARRAY MOUNTING	
MTL	Part	Description	QTY
10	0005849	LUBRICANT SILICONE	1
20	0011290	ASSY SUB PLATE MOUNTING DW 106 DUCER	2
40	0010127	DOC DRAWING ICD DW 106 DUCER	1
50	0010125	HARDWARE STANDOFF STD ROUND DW 106 FEMALE / FEMALE 01 INCH OD 9.44 INCH LENGTH 3/8-16 X 2 TAP AL	8
60	0005270	HARDWARE SCREW STD MACHINE CAP SOCKET HD HEX 3/8-16 0.75 INCH 316 SS	12
70	0007220	HARDWARE WASHER STD SPLIT LOCK 0.375 INCH 316 SS	28
80	0011308	HARDWARE SCREW STD CAP HEX HD 3/8-16 01 INCH 316 SS	4
90	0005245	HARDWARE BOLT STD CAP HEX HD 3/8-16 1.50 INCH 316 SS	8
100	0007172	HARDWARE WASHER STD FLAT 0.375 INCH 316 SS	16
110	0018843	ANODE SPHERICAL SEGMENT 1.875 INCH DIA X 0.35 INCH	4
120	0007212	HARDWARE WASHER STD SPLIT LOCK 0.25 INCH 316 SS	4
140	0005375	HARDWARE SCREW STD MACHINE PAN HD PHILLIPS 1/4-20 0.50 INCH 18-8 SS	4
150	0016090	CABLE EXTENSION DUCER SIDESCAN 2205 PASSIVE DF MCIL8M MCIL8F 2M	2
160	0019472	PLATE MOUNTING 20 INCH 29 INCH PVDF HYDROPHONE SIGNAL CONDITIONING	1
170	0012248	PIGTAIL 13 POS FEMALE SUBCONN DIL13F MACARTNEY POWER / ETHERNET CABLE 1M	1
180	0010124	BRACKET ADAPTER DW 106 DUCER AL	2

Table 8-2: 0022261 AUV/ROV Mounting Kit